

## ARTICLE FOUR. DEVELOPMENT STANDARDS.

---

### 50-21 DIMENSIONAL STANDARDS.

---

#### 50-21.1 General dimensional standards.

---

##### A. Residential, mixed use, special purpose and overlay zones.

The dimensional standards for residential, mixed use, special purpose and overlay districts are shown in the description for each district in the following Sections of Article II:

- Standards for residential districts are shown in Section 50-14;
- Standards for mixed Use districts are shown in Section 50-15;
- Standards for special purpose districts are shown in Section 50-17; and
- Standards for overlay districts are shown in Section 50-18.

All dimensional standards shown in Article II are subject to the special dimensional standards in Section 50-21.2 and the exceptions and encroachments in Section 50-21.3 unless specifically noted;

##### B. Form districts.

The dimensional standards for form districts are integrated into descriptions of each form-based district in Article II and the building form standards in Section 50-22. The special dimensional standards in Section 50-21.2 and the exceptions and encroachments in Section 50-21.3 do not apply in the form districts unless specifically noted. (Ord. No. 10044, 8-16-2010, § 6.)

#### 50-21.2 Special dimensional standards.

---

##### A. Lot without municipal sewer.

Lot areas for properties not provided with municipal sewer shall be at least two acres in size or the minimum lot area for the zone district, whichever is larger, and shall be subject to county ordinances and standards regulating individual sewage treatment systems. Lots with large wetlands or shallow bedrock may be required to be larger than two acres, and shall be determined on a case-by-case basis based on the area needed to fit a sewage treatment system on the site. Lots smaller than two acres may be allowed in areas zoned R-P based on soil and site conditions;

##### B. Front yards on double frontage lots.

On lots having double frontage and where the first and second frontages are on opposite lot lines, the required front yard shall be provided on the frontage that is the generally established frontage on the block, as determined by the building official;

##### C. Side yards.

###### 1. Dwelling units above commercial uses.

In all residential and mixed use districts, where dwelling units are erected above commercial establishments, no residential side yard is required, except for any side yard required for the commercial building on the side of a lot adjoining a residential district. In form districts, no side yard is required even if the lot adjoins a residential district;

###### 2. Attached and multi-family dwellings.

For the purpose of side yard regulations, a two-family dwelling, townhouse, or multi-family dwelling shall be considered as one building occupying one lot;

###### 3. Driveways.

Where no garage facilities are provided and the alley is not developed for access at the time the dwelling is constructed in an R-1 or R-2 district, there shall be provided one side yard of a minimum of nine feet for a driveway and the other side yard shall have a minimum width of five feet;

**D. Accessory structures.**

Accessory dwelling units shall not exceed the height of the principal residential structure or 20 feet, whichever is greater. All other accessory structures shall not exceed 20 feet in height.

Any accessory structure shall not occupy more than 30 percent of the rear yard area. All accessory structures on a lot shall not occupy more than 60 percent of the rear yard area.

An unattached deck that is 5 feet or closer to a primary structure must adhere to the same setbacks as primary structures in that zone district. An unattached deck that is greater than 5 feet from a primary structure must adhere to the accessory structure setbacks.

**E. Street improvements in public right of way.**

Except as provided in Section 50-37.1.L, for development or redevelopment proposed on lots without a principle structure:

1. The street shall be improved to the most current standards on file in the office of the city engineer and shall be designed for the road classification within the zone in which the property is located;
2. The street shall be improved across the entire frontage of the lot proposed to be developed and all other contiguous property owned by the owner of the subject lot;
3. Any street improvement that results in a dead-end street that is greater than 150 feet in length shall require construction of a turn-around for emergency and maintenance vehicles approved by the city fire marshal.

For lots developed with an existing legal principle structure, the street improvement requirements need not be met when the landowner proposes an expansion of the existing legally constructed structure or a replacement principle structure, if the landowner provides evidence of a perpetual easement to access the property from an improved street of a distance not greater than 150 feet, and such access shall be improved to meet Fire Code standards.

**F. Common Open Space.**

1. All structures intended to be owned and occupied by an individual unit owner of a Common Interest Community shall be constructed within the space allocated in the governing documents for that specific unit owner, except as allowed in section 2 below;
2. A Home Owner Association or other applicable governing body of the community may grant building easements, with city approval as provided for in this sub-paragraph below, to allow encroachments of structures into the common open space as platted in the Common Interest Community Plat. In such instances, the building easement shall be considered part of the adjacent building parcel or unit. Before constructing any such encroaching structure, the owner of said adjacent building parcel or unit shall file with the Planning Department a copy of a recorded easement and survey depicting same by the private landowner are required to verify the circumstances in each instance. The Land Use Supervisor may grant city approval for the proposed building easement(s) if they do not impact more than 10% of the common open space of the community; the Planning Commission may grant city approval for impacts more than 10%. In no event can more than 30% of the common open space of the community be impacted. The Land Use Supervisor or Planning Commission may require the CIC to be re-platted to reflect the change in the reduced common open space. Ord. No. 10044, 8-16-2010, § 6; Ord. No. 10096, 7-18-2011, § 21; Ord. No. 10225, 5-28-2013, § 8; Ord. No. 10337, 11-24-2014, § 2; 10591, 9-24-18, § 1; Ord. No. 10659, 10-28-19, §9)

**50-21.3 Exceptions and encroachments.**

The following exceptions and encroachments to required yard areas and height limits are allowed. These provisions do not apply to form districts except as specifically noted in exceptions to building heights.

**Table 50-21-1: Exceptions and Encroachments**

Structure or Feature	Conditions or Limits
<b>Encroachments into Required Yard Areas</b>	
Architectural features (sills, belt courses, eaves, cornices) awnings and canopies, bay windows, gutters and downspouts	Up to 18 in. into any required yard area
Unenclosed or lattice-enclosed stairs, fire escapes and balconies opening upon fire towers	Up to 5 ft. into any required rear yard, except as required to comply with applicable fire code or Americans with Disabilities Act
Chimneys and flues	Up to 2 ft. into any required front or side setback.
Open sided porch, deck, or paved terrace	Up to 10 ft. into front yard, but no closer than 5 ft. from any property line
Enclosed vestibule or fixed canopy with a floor area of not more than 40 sq. ft.	Up to 4 ft. into front yard
Fuel pumps or pump islands	Not closer than 15 ft. from any street line or closer than 50 ft. from any residential use
Fences meeting the standards of Section 50-26.4	Fences may not be located closer than 3 ft. to any publicly maintained right-of-way
Porte cochere, carport or canopy if every part is unenclosed except for necessary structural supports	Permitted in any side setback, but not less than 5 ft. from any side lot line
Residential window well	Permitted to encroach up to two feet from any property line, provided that window well: (a) has a minimum distance of at least 5 feet from any structure on any adjacent property, and (b) is limited to the minimum window well depth and width required by fire and building codes.
Accessory structures	No accessory structure may be located: (a) between a street and any façade of a primary building facing that street, or (b) closer than 10 ft. to any principal structure on an adjoining property, or (c) closer than 5 ft. to any rear lot line, or (d) closer than 3 ft. to any side lot line, except as listed for specific accessory structures below.
<i>Accessory structures in MU-W</i>	If 200 square feet or larger, not closer than 25 feet to any side or rear lot line, and not closer than 25 to any existing principal or accessory structure.
<i>Accessory boat dock, residential</i>	No setback required from property lines along the water
<i>Accessory clotheslines, play equipment, trash containers, odor-controlled composting bins and rainwater harvesting tanks</i>	Permitted in side and rear yards
<i>Accessory rain garden</i>	Permitted in all (front, side and rear) yards
<i>Accessory wind power equipment</i>	Permitted in side and rear yards except where prohibited by adopted building code
<b>Exceptions to Building Height Limits</b>	
Television and radio towers, accessory communications towers for private use, religious assembly or ornamental spires and towers, belfries, monuments, tanks, water and fire towers, stage tower or scenery lofts, cooling towers, chimneys, elevator penthouses, air conditioning penthouses, skylights, smokestacks, conveyors, storage elevators and facilities, flagpoles, accessory wind power equipment or accessory rooftop solar collectors	In the Form District, the exceptions to building height limits for religious assembly or ornamental spires and towers only apply if the applicant proposes an Iconic Building

50-21 Dimensional Standards

(Ord. No. 10044, 8-16-2010, § 6; Ord. No. 10096, 7-18-2011, § 22; Ord. No. 10286, 3-10-2014, § 9. Ord. No. 10457, 7-11-2016, § 1, 10591, 9-24-2018, § 2)

## 50-22 BUILDING FORM STANDARDS

The following provisions apply only in the form districts listed in Section 50-16, but do not apply in other zone districts. (Ord. No. 10044, 8-16-2010, § 6; cited only by Ord. No. 10284, 3-10-2014, § 2.)

### 50-22.1 General requirements.

#### A. Intent.

The building types detailed in this Section outline the desired building forms for new construction and renovated structures within the form districts;

#### B. Applicability.

1. All building type standards apply to all new construction and renovation of existing structures, where the renovation includes an addition of more than 50 percent in building square footage;
2. When a renovation of the front facade occurs with no added building square footage, the street facade requirements and base type requirements must be met when:
  - (a) The existing building front, corner, or lakefront facade is located within the build-to zone;
  - (b) The renovation includes any of the following:
    - (i) Installation of additional doors or a change in location of a door;
    - (ii) Expansion or change in location of 30 percent of windows on any street or lakefront façade;
    - (iii) Replacement of 30 percent or more of facade materials on any street or lakefront facade with a different facade material;
3. When a renovation of the shape or style of the roof occurs with no added building square footage, the cap type requirements must be met when the existing building front, corner or lakefront facade is located within the build-to zone;
4. Under all circumstances, no portion of the building type standards must be met in the case of normal repairs required for safety and continued use of the structure, such as replacement of window or door glass;

#### C. General requirements.

All construction in the form districts must meet the following requirements:

1. Zone districts.  
No primary building shall be developed within a form district unless it matches one of the building types approved for that district in Table 50-22.2-1;
2. Planning review required.  
Development of any building type must be reviewed and approved by the city through the planning review process in Article V;
3. Permanent structures.  
All buildings constructed must be permanent construction without a chassis, hitch, or wheels, or other features that would make the structure mobile. Temporary structures and uses are permitted as shown in Article III;

#### D. Alternative compliance for renovation of existing primary structures.

Where compliance with the specific requirements of Section 50-22 is not possible as a result of unique site conditions, an owner may propose alternatives consistent with the goals of sections 50-16 and 50-22. Approval of an alternative approach is authorized where an applicant can demonstrate the following:

1. The renovation does not increase the existing primary structure's footprint; and
2. The proposed renovation achieves the goals stated in Section 50-16 relevant to the particular form district to the same degree, or better than, the building form standards set forth in Section 50-22. (Ord. No. 10044, 8-16-2010, § 6; Ord. No. 10153, 5-14-2012, § 3; cited only by Ord. No. 10284, 3-10-2014, § 2.)

### **50-22.2 General building type descriptions.**

---

Four major categories of building types are described in this Section: Main Street Building, Corridor Building, Cottage Commercial Building, and Iconic Building. The building types proposed for the Form Districts include three variations of the Main Street Building, three variations of the Corridor Building, two variations of the Cottage Commercial Building, and one version of the Iconic Building. The building type variations go from least intense (Type I) to most intense (Type III);

#### **A. Main street buildings.**

Main street buildings, in general, are pedestrian-oriented, mixed use buildings. This building type typically has a storefront on the ground floor with offices or residential uses on the upper floors. The ground floor of the Main Street Building has a high amount of transparency, so that pedestrians walking by can look into the interior space.

1. Main street building I.  
This building type allows for service, retail, and office uses on the ground floor and office or residential above. It is appropriate for commercial uses adjacent to residential neighborhoods, as the intensity of this building type is not as high as the other main street building types. It has a larger build-to zone and a maximum height of two-and-a-half or three stories depending on location;
2. Main street building II.  
Main street building II is slightly more intense than main street building I, as it is required to be built up to the right-of-way and may generally be up to four stories tall. This building type also permits service, retail and office uses on the ground floor and office or residential on upper floors;
3. Main street building III.  
Main street building III is the most intense of the main street building types, as it is meant to be used in the downtown area. It is located directly adjacent to the sidewalk and should include retail or service uses on the ground floor whenever possible. Main street building III has a maximum height of 15 stories in limited locations;

#### **B. Corridor buildings.**

Corridor buildings are primarily meant to house office or multi-family residential uses, with less transparency required on the ground floor.

1. Corridor building I.  
This building type can house a single category of uses, such as office or residential, or a mix of uses. Corridor building I is the least intensive corridor building, located in the more neighborhood oriented study area locations. It has a larger build-to zone that is set back farther than the other corridor buildings and is permitted to be a maximum of three stories;
2. Corridor building II.  
Corridor building II is an intermediary building type between the more neighborhood scale locations and the intensity of Downtown. It is similar to corridor building I in many ways, but is permitted to be built up to the sidewalk and may also be taller, with generally a maximum height of four stories;
3. Lakefront corridor building.  
The lakefront corridor building is a variation on corridor building II that was created for use along Lake Superior in Canal Park. These buildings front the lake, but also require some level of frontage on Canal Park Drive. The maximum height is four stories;

4. Corridor building III.

Corridor building III was created for use in Downtown. It is required to be built adjacent to the sidewalk and has a maximum height of 15 stories in specified locations. While the corridor building types are meant to house primarily office and residential uses, commercial uses are also permitted to create a vibrant commercial core for Downtown;

**C. Cottage commercial.**

The cottage commercial building is primarily commercial in nature but, unlike the Main Street Building, it is similar in form to single-family residential areas, providing transitions between commercial and residential areas.

1. Cottage commercial I.

The cottage commercial building type is residential in character but commercial in use. At a maximum height of two and a half stories, it is meant to blend in with a surrounding residential neighborhood while at the same time providing neighborhood-scale commercial uses. Cottage commercial I is for use as a transition to residential locations, with a larger build-to zone and permitted side aisle of parking. Cottage commercial I may also include multiple principal structures on one lot, provided that each building meets the requirements of the building type;

2. Cottage commercial II.

Cottage commercial II is similar to cottage commercial I but is used in the West Duluth study area, which is a more intense context. This building type may be built to the front property line and must locate parking in the rear;

**D. Iconic building.**

While the previously mentioned building types are intended to serve as the fabric buildings of the city, the iconic building is a unique civic or institutional building that has distinctive character and function within the community. The iconic building has more flexible requirements for building location and transparency than the other non-residential building types due to its unique nature and importance to the community;

The iconic building type is meant to house community, cultural, civic, educational or governmental uses (i.e. uses classified as “Community and Cultural Facilities” or “Educational Facilities” in Table 50-19.8). Properties that are designated as local historic landmarks may contain any land use allowed in 50-19.8 for the zone district that the property is located, and are not limited to only community and cultural facilities or educational facilities;

(Ord. No. 10722, 12-14-2020, § 4)

**Table 50-22.2-1: Summary Table of Permitted Building Types by Zone District.**

		Building Types									Areas	
		Main Street Building I	Main Street Building II	Main Street Building III	Corridor Building I	Corridor Building II	Lakefront Corridor Building	Corridor Building III	Cottage Commercial I	Cottage Commercial II		Iconic Building
<b>Districts</b>	F1: Low-Rise Neighborhood Shopping	●										East Superior
	F2: Low-Rise Neighborhood Mix	●			●				●		●	East Superior, London Road
	F3: Mid-Rise Community Shopping		●									West Duluth, Canal Park
	F4: Mid-Rise Community Mix		●			●				●	●	West Duluth London Road
	F5: Mid-Rise Community Shopping/Office		●			●					●	West Superior, Canal Park
	F6: Mid-Rise Neighborhood Shopping		●			●			●		●	Central Hillside
	F7: Downtown Shopping			●								Downtown
	F8: Downtown Mix			●				●			●	Downtown
	F9: Canal Park						●					Canal Park

● Building Type permitted

(Ord. No. 10044, 8-16-2010, § 6; Ord. No. 10096, 7-18-2011, § 23; Ord. No. 10284, 3-10-2014, § 2.)

**50-22.3 Base types.**

Base type standards apply to the ground story and visible basement of front facades of all building types. To determine which base type(s) are permitted for each building type, refer to the building types-specific information found in sections 50-22.7 through 50-22.17.

**A. General provisions.**

The following provisions apply to all base types.

1. Intent. To guide the design of the ground story of all buildings to relate appropriately to pedestrians on the street. Treatment of other portions of the building facades is detailed in each building type standard (refer to 50-22.7 through 50-22.17);
2. Applicability. The entire ground story front facade of all buildings must meet the requirements of one of the permitted base types, unless otherwise stated in this Section;
3. Measuring transparency. Refer to Section 50-22.5.D.1 for information on measuring building transparency;
4. Visible basements. Visible basements, permitted by base type, are optional;
5. Expression lines. For the purposes of this Section, expression lines are an architectural feature comprised of a decorative, three dimensional, linear element, horizontal or vertical, protruding or



indented at least one inch from the exterior facade of a building, and extending the length or height of the building with minimal interruptions from doors and windows. It is typically used to delineate the floors or stories of a building;

#### B. Storefront base type.

The storefront base type is a highly transparent ground story treatment designed to serve as the display area and primary entrance for retail or service uses. (Refer to Figure 50-22.3-A)

1. **Transparency.** A minimum of 75 percent of the front facade between two and eight feet above the sidewalk must be comprised of transparent, non-reflective windows into the commercial space. A minimum of 25 percent of the windows shall have views directly into and out of the ground floor occupied space;
2. **Elevation.** Ground story elevation must be less than or equal to one foot above sidewalk;
3. **Visible basement.** A visible basement is not permitted;
4. **Facade divisions.** Expression lines shall divide the facade into segments;
  - (a) Vertically divide the base facade into segments no greater than 30 feet in width;
  - (b) Horizontally define the base facade from the upper stories;
5. **Entrance.** All entries shall be recessed from the front facade closest to the street;
  - (a) Recess shall be a minimum of three feet and a maximum of eight feet deep, measured from the portion of the front facade closest to the street;
  - (b) When the recess falls behind the front build-to zone, the recess shall be no wider than eight feet;

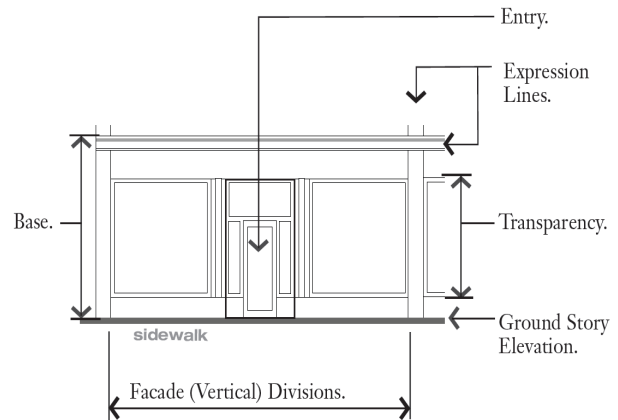
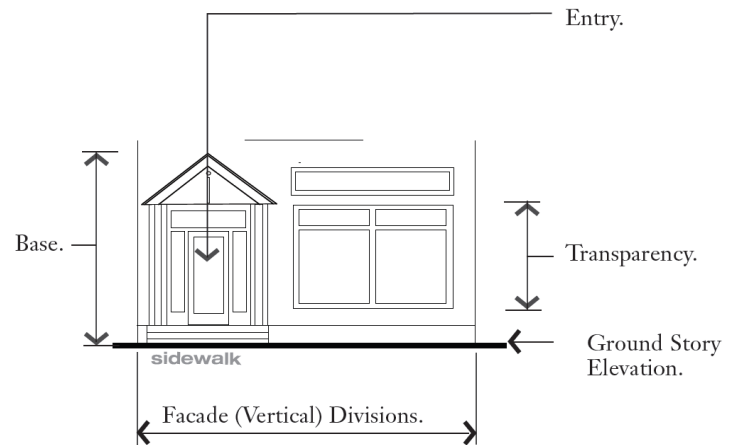

**Figure 50-22.3-A: Storefront base type**

**C. Shopfront base type.**

The shopfront base type treatment includes less transparency than the storefront, while still allowing views in and out of the commercial space, and an entrance off of a porch or stoop. (Refer to Figure 50-22.3-B)

1. Transparency. A minimum of 50 percent of the front facade between three and nine feet above the sidewalk must be comprised of transparent, non-reflective windows into the commercial space;
2. Elevation. Ground story elevation must be between zero and three feet above sidewalk and not less than six inches above the curb, with or without optional visible basement;
3. Visible basement. A visible basement is permitted;
4. Vertical facade divisions. For buildings wider than 50 feet, divide base facade into segments no greater than 50 feet in width with an expression line;
5. Entrance. Porch or stoop entrance required;

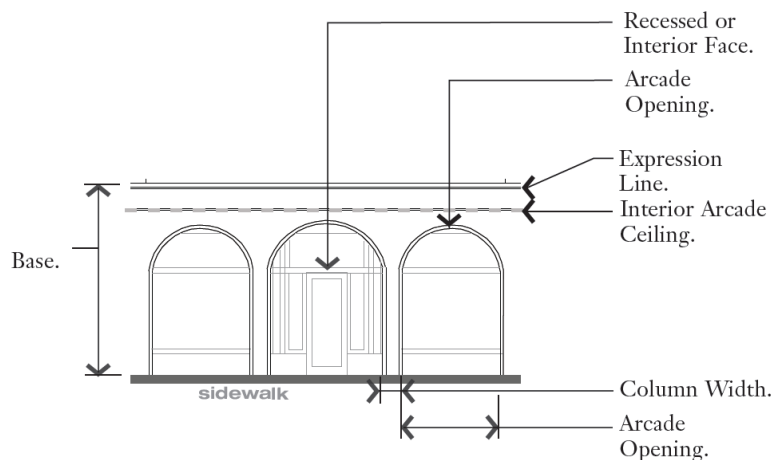

**Figure 50-22.3-B: Shopfront base type**

**D. Arcade base type.**

An arcade base type is a covered pedestrian walkway within the recess of a ground story. (Refer to Figure 50-22.3-C)

1. Arcade. An open-air public walkway is required from the face of the building recessed into the building a minimum of eight and a maximum of 15 feet;
2. Recessed or interior facade. Storefront or shopfront base types are required on the recessed ground story façade;
3. Column spacing. Columns shall be spaced between ten feet and 12 feet on center;
4. Column width. Columns shall be a minimum of one foot, eight inches, and a maximum two feet, four inches, in width;
5. Arcade opening. Opening may not be flush with interior arcade ceiling and may be arched or straight;
6. Horizontal facade division. Horizontally define the base facade from the upper stories;
7. Visible basement. A visible basement is not permitted;



**Figure 50-22.3-C: Arcade base type**

**E. Stoop base type.**

A stoop is an unroofed, open platform. (Refer to Figure 50-22.3-D)

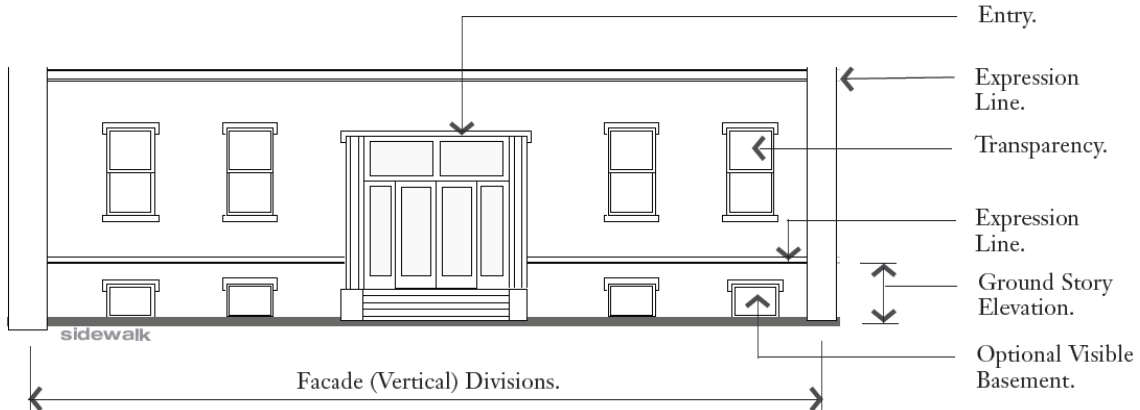
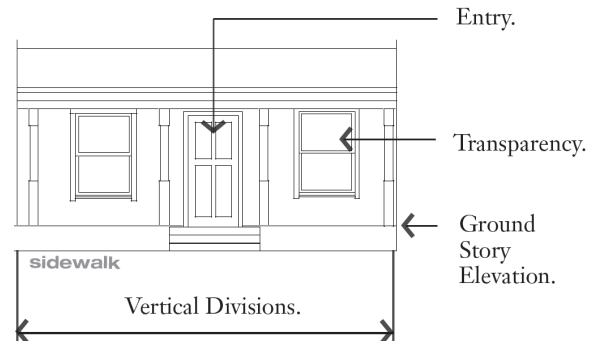

**Figure 50-22.3-D: Stoop base type**

1. Transparency. Minimum transparency per building type is required;
2. Stoop size. Stoops shall be a minimum of three feet deep and four feet wide;
3. Elevation. Ground story elevation must be located a maximum of two feet, six inches, above the sidewalk without visible basement and a maximum of four feet, six inches, above the sidewalk with a visible basement;
4. Visible basement. A visible basement is permitted;
5. Facade divisions. Expression lines shall divide facade segments;
  - (a) Vertically divide the base facade into segments no greater than 100 feet in width;
  - (b) Horizontally define the base facade from upper stories;
6. Entrance. All entries shall be located off a stoop;

**F. Porch base type.**

A porch is a raised, roofed platform that may or may not be enclosed on all sides. (Refer to Figure 50-22.3-E)



**Figure 50-22.3-E: Porch base type**

1. Transparency:
  - (a) Minimum transparency per building type is required;
  - (b) If enclosed, a minimum of 40 percent of the enclosed porch must be comprised of transparent, nonreflective windows;
2. Porch size. The porch shall be a minimum of five feet deep and maximum of eight feet wide;
3. Elevation. Ground story elevation must be located a maximum of two feet, six inches, above the sidewalk without visible basement, and a maximum of four feet, six, inches, above the sidewalk with a visible basement;
4. Visible basement. A visible basement is permitted;
5. Facade divisions. Use expression lines to divide facade segments;
  - (a) Vertically divide base facade into segments no greater than 60 feet in width;
  - (b) Horizontally define the base facade from upper stories;

6. Height. Porch may be two stories to provide a balcony on the second floor;
7. Entrance. All entries shall be located off a porch. (Ord. No. 10044, 8-16-2010, § 6; cited only by Ord. No. 10284, 3-10-2014, § 2.)

#### 50-22.4 Cap types.

Cap type standards apply to the cap of all building types as required in this Section.

##### A. General provisions.

The following provisions apply to all cap types.

1. Intent. To guide the design of building caps in order to ensure an appropriate and aesthetically pleasing cap for all buildings;
2. Applicability. All buildings must meet the requirements of one of the cap types permitted for the building type;
3. Measuring height. Refer to the definition of “height of building” in Article VI;
4. Other cap types. The Iconic building type may seek to incorporate other building caps not listed as a specific type by applying for a special use permit pursuant to Section 50-37.10, but the height may not exceed the maximum height of the tallest cap type permitted for the building type;

##### B. Parapet cap type.

A parapet is a low wall projecting above a building’s roof along the perimeter of the building. It can be utilized with a flat or pitched roof and also serves to limit the view of roof-top mechanics from the street. (Refer to Figure 50-22.4-A)

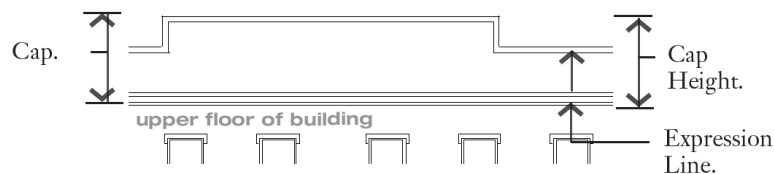

**Figure 50-22.4-A: Parapet cap type**

1. Parapet height. Height is measured from the top of the upper story to the top of the parapet;
  - (a) Minimum height is two feet with a maximum height of six feet;
  - (b) Cap shall be high enough to screen the roof and any roof appurtenances when viewed from the street(s) and any adjacent building of similar height;
2. Horizontal expression lines. An expression line shall define the cap from the upper stories of the building and shall also define the top of the cap;
3. Occupied space. Occupied space may not be incorporated behind this cap type;

### C. Pitched roof cap type.

This cap type has a sloped or pitched roof. Slope is measured with the vertical rise divided by the horizontal span or run. (Refer to Figure 50-22.4-B)

1. Pitch measure. The roof may not be sloped flatter than a 6:12 (rise:run) or steeper than 16:12 (rise:run);
2. Roof types. Hipped, gabled, and combination of hips and gables with or without dormers are acceptable. Gambrel and mansard roofs are acceptable provided that when the ridge runs parallel to the street, one dormer per 15 feet of street face is required;
3. Parallel ridge line. A gabled end or perpendicular ridge line shall occur at least every 100 feet of roof for two-story buildings or higher and at least every 50 feet of roof for one-story buildings when the ridge line runs parallel to the front property line;
4. Roof height. Roof height may not be greater than the total of all floors below the roof. For single story portions of the building, roof height may not exceed one-and-one-half times the floor below the roof; (Ord. No. 10457, 7-11-2010, § 2)

**Figure 50-22.4-B: Pitched roof**

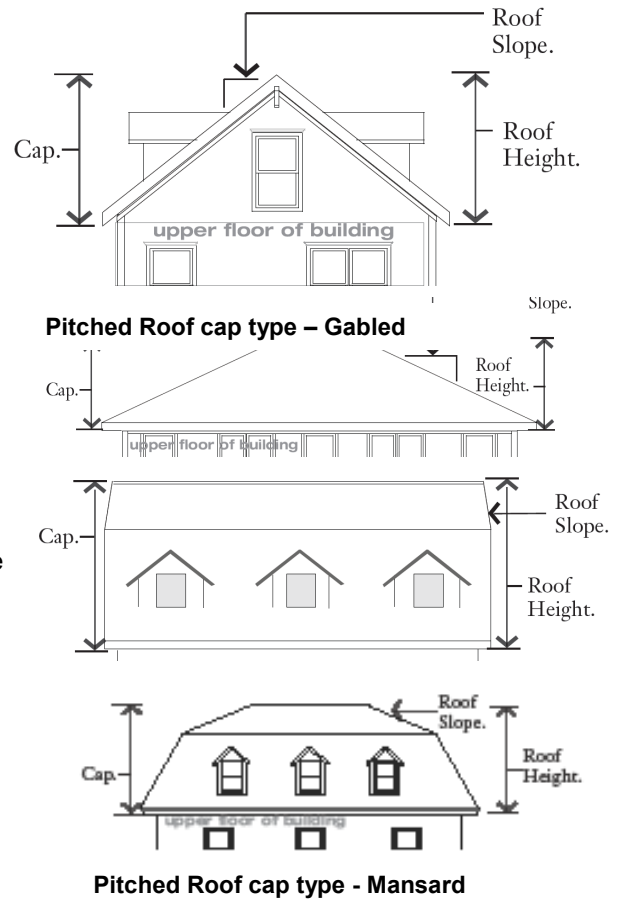

**D. Flat Roof cap type.**

This cap type has a flat roof with overhanging eaves. (Refer to Figure 50-22.4-C)

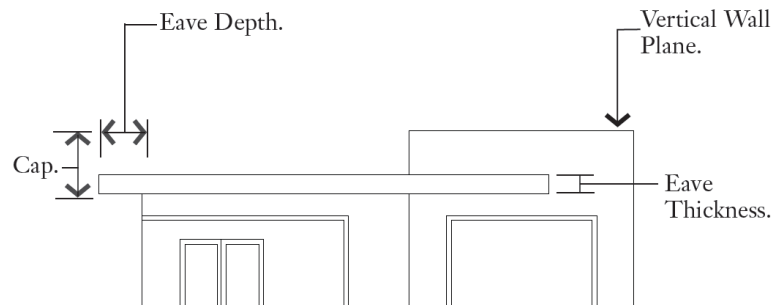

**Figure 50-22.4-C: Flat roof**

1. Roof types. Roofs with no visible slope are acceptable. Eaves are required on all street-facing facades;
2. Eave depth. Eave depth is measured from the building façade to the outside edge of the eave. Eaves shall have a depth of at least 12 inches;
3. Eave thickness. Eave thickness is measured at the outside edge of the eave, from the bottom of the eave to the top of the eave. Eaves shall be a minimum of six inches thick;
4. Interrupting vertical walls. Vertical walls may interrupt the eave and extend above the top of the eave with no discernible cap;
  - (a) No more than one-half of the front façade can consist of an interrupting vertical wall;
  - (b) Vertical walls shall extend no more than four feet above the top of the eave;

**E. Towers.**

A tower is a rectilinear or cylindrical vertical element that must be used with other cap types. (Refer to Figure 50-22.4-D)

1. Quantity. One tower is permitted per building;
2. Tower height. Maximum height, measured from the top of the upper story to the top of the tower, is the equivalent of the height of one upper floor of the building to which the tower is applied;
3. Tower width. Maximum width along all facades is one-third the width of the front facade or 30 feet, whichever is less;
4. Occupied space. Towers must be occupied by the same uses allowed in upper stories of the building type to which it is applied;
5. Tower cap. The tower may be capped by the parapet, pitched, or flat roof cap types. (Ord. No. 10044, 8-16-2010, § 6; cited only by Ord. No. 10284, 3-10-2014, § 2.)

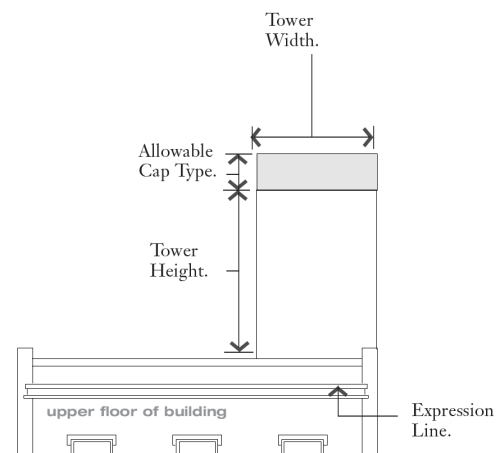

**Figure 50-22.4-D: Tower**

**50-22.5 Explanation of table requirements.**

The following explains and defines the requirements included in the tables for each building type, sections 50-22.7 through 50-22.17, and summarized for all building types in Table 50-22.2.

**A. Building siting.**

## 1. Street frontage.

(a) Multiple principal buildings permitted on a lot. The presence of more than one principal structure on a lot;

(b) Front build-to zone (BTZ) or setback. The build-to zone or setback parallel to the front property line. All BTZ and setback areas not covered by the building must contain either landscaping, patio space, or sidewalk space. Build-to zones define the minimum and maximum distance a structure may be placed from a property line;

(c) Corner BTZ or setback. The build-to zone or setback parallel to the corner property line. All BTZ and setback areas not covered by building must contain landscape area;

(d) Minimum coverage of front BTZ. Measurement defining the minimum percentage of street wall or building facade required along the street. The width of the principal structure(s) (as measured within the front build-to zone) shall be divided by the maximum width of the front. Refer to Figure 50-22.5-A;

(e) Occupation of corner. Occupying the intersection of the front and corner build-to zones with a principal structure;

## 2. Side and rear setbacks.

(a) Minimum side yard setback. The minimum required setback along a side property line. All side yard setback areas not covered by building must contain landscape area;

(b) Minimum rear yard setback. The minimum required setback along a rear property line;

## 3. Buildable area.

(a) Minimum landscape area. The minimum percentage of a lot that must be primarily dedicated to landscape materials, such as planting beds, grass or shrubs. A portion of the area may include hardscape materials for pedestrian use or access to the area or building, such as patio or sidewalk;

(b) Minimum lot width. The minimum width of a lot, measured at the front property line;

## 4. Parking and access.

(a) Location of parking facilities. The yard in which a parking lot and associated drive is permitted;

(b) Loading facility location. The facade of the building on which access is permitted for loading and unloading activities related to building uses;

(c) Number of permitted driveways. Defines the circumstances under which a driveway is permitted on a lot;

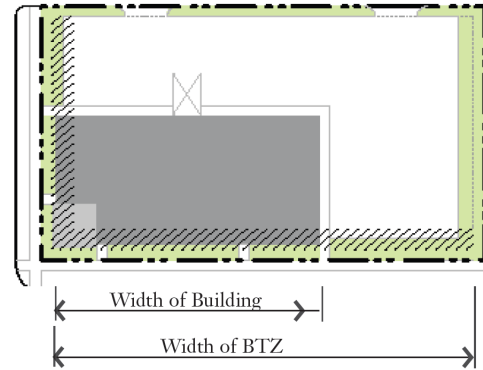

**Figure 50-22.5-A: Measuring BTZ Coverage**

## B. Height.

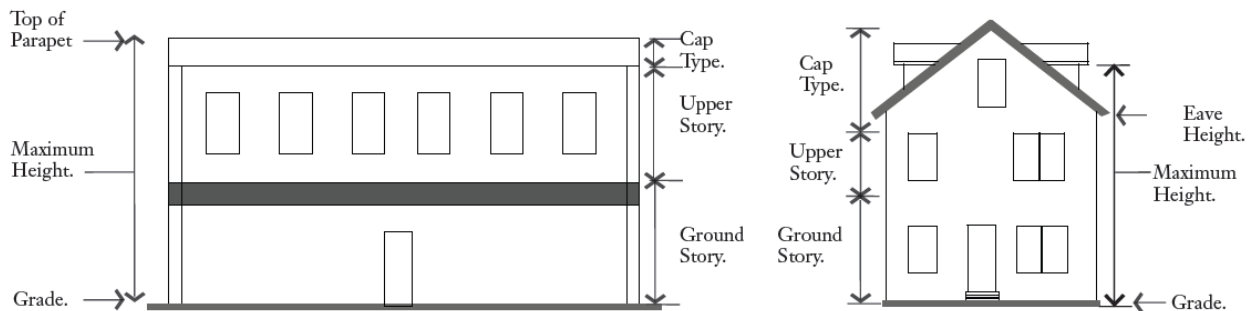

**Figure 50-22.5-B: Measuring Height**

1. Minimum and maximum overall height. ( Refer to Figure 50-22.5-B)
2. A required minimum and maximum overall height is provided for all building types and is measured as follows:
  - (a) Height in stories. The sum of a building's stories. Half stories are located either completely within the roof structure or in a visible basement exposed a maximum of one-half story above average finished grade;
  - (b) Height in feet measured as follows:
    - (i) Parapet cap type. Overall height is measured from the average finished grade of the building's front facade to the highest point of the parapet;
    - (ii) Pitched cap type. Overall height is measured from the average finished grade of the building's front facade to the midpoint of the highest roof slope;
    - (iii) Flat Roof cap type. Overall height is measured from the average finished grade of the building's front facade to the top of the highest eave;
    - (iv) Appurtenances. Chimneys, antennae and other similar appurtenances may exceed the overall building height by no more than 25 feet;
    - (v) Towers. Maximum height, measured from the top of the upper story to the top of the tower, is the equivalent of the height of one upper floor of the building to which the tower is applied. This additional floor does not count toward the overall height of the building. Refer to Section 50-22.4 (E);
3. Ground story and upper story minimum and maximum height. (Refer to Figure 50-22.5-B.) Each building type includes a permitted range of height in feet for each story, which is measured as follows:
  - (a) Floor height is measured in feet from the floor of a story to the floor of the story above it;
  - (b) For single story buildings and the uppermost story of a multiple story building, floor to floor height shall be measured from the floor of the story to the tallest point of the ceiling;
4. Where a building spans a block, and the block is adjacent to two street frontages with different building height maximums, the maximum height is determined as follows:
  - (a) Where a block is adjacent to two streets with different maximum building heights, the midpoint between those two streets is the point where the maximum building height transition occurs;
  - (b) Where a block is between Superior Street and Michigan Street, the greater maximum building height allowed on Superior Street extends through the entire block to Michigan Street;



5. In the situation where a single party owns frontage along a street corner, the maximum height for corner parcels applies to lots with the same street frontage owned by the same property owner within 100 feet of the corner;
6. For structures within the downtown area of the Downtown and Canal Park Special Parking District as shown in 50-24.1, the maximum height for all building types may exceed the maximum height normally allowed for the specific building type as shown in 50-22.7 by 50% if the building's proposed use meets specific housing priorities of the City as described in the most recently adopted Comprehensive Plan, but may not exceed 200 feet in any event.

(Ord. No. 10722, 12-14-2020, § 5)

**C. Uses.**

1. Ground story. The uses that may occupy the ground story of a building. Refer to Article III, *Permitted uses*;
2. Upper story. The uses that may occupy the upper stories of a building. Refer to Article III, *Permitted uses*;
3. Parking within building. The area(s) of a building in which parking is permitted within the structure;
4. Occupied space. The area(s) of a building that must be occupied by the users on a regular basis;

## D. Facade requirements.

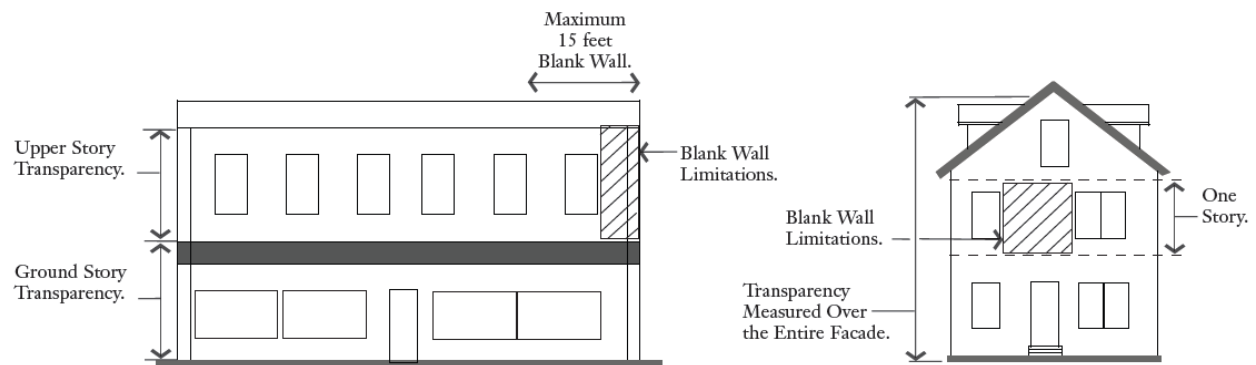

**Figure 50-22.5-C: Measuring transparency**

1. Transparency. Measurement of the percentage of a facade that has clear, non-reflective windows. Refer to Figure 50-22.5-C;
  - (a) Minimum transparency. The minimum amount of transparency required on the upper stories of facades with street frontage, measured per story or per facade, depending on the building type. Buildings with storefront and shopfront base types are required to have a greater ground story transparency on the front facade, as defined in Section 50-22.3, *Base types*;
  - (b) Blank wall limitations. A restriction of the amount of windowless area permitted on a facade with street frontage. If required, the following shall be met:
    - (i) No rectangular area greater than 30 percent of a story's facade, as measured from floor to floor, may be windowless; and
    - (ii) No horizontal distance greater than 15 feet of a story's facade may be windowless;
2. Building entrance.
  - (a) Principal entrance location. The facade on which the primary building entrance is to be located;
  - (b) Street facades. Number of entrances on street facade. The maximum spacing between entrances on a building facade with street frontage;
3. Balconies. The following requirements pertain to balconies on building facades with street frontage;
  - (a) Size. The minimum dimensions of a permitted balcony;
  - (b) Facade coverage. The percentage of a facade's total area that may be covered by balconies, including street facing railing and balcony structure;
  - (c) Access. The number of units that are permitted to gain entry to an individual balcony;
  - (d) Structure. Requirements related to the construction of a balcony. Two types of balcony structures are permitted:
    - (i) Independently secured balconies are those that are connected directly to the building and are unconnected to other balconies;
    - (ii) Balconies that are integral to the facade are a part of, and built in conjunction with, the building structure;

**E. Cap and base type requirements.**

1. Cap type. The cap type(s) permitted for a given building type. Refer to 50-22.4, *Cap types*, for more specific requirements;
2. Tower. A vertical building extension that may be permitted in conjunction with another cap type on certain building types. Refer to 50-22.4(E), *Cap types*;
3. Front street facade base type. The base type(s) required on the street-facing facade of a given building type. Refer to 50-22.3, *Base types*, for more specific requirements;
4. Parking lot facade base type. The base type(s) required on the facade of a given building type that faces a parking lot. Refer to 50-22.3, *Base types*, for more specific requirements;

**F. Façade materials requirement.**

The materials prohibited, required and to be avoided for designated facades. (Ord. No. 10044, 8-16-2010, § 6; Ord. No. 10284, 3-10-2014, § 2.)

**50-22.6 Additional development standards.**

The following provides additional required physical standards for the uses outlined as permitted in Article III, *Permitted uses*.

**A. Automobile and light vehicle repair and service.**

1. Service bays. Vehicular service bays, including garages and car wash bays, shall not be located on the front façade;
2. Outdoor activities. All repairs or washing activities must occur inside a structure;

**B. Filling station: fuel pumps and canopies.**

Refer to Figure 50-22.6-A.

1. Fuel pumps are permitted in the side or rear yards;
2. If a lot containing fuel pumps is adjacent to any residential district, the boundary with those districts shall be buffered in accordance with the standards in Section 50-25.5.B;
3. Canopy roof structures shall match the roof structure of the principal structure on the lot;
4. Canopy height shall not exceed the height of the principal structure on the lot;
5. Signage is not permitted on the canopy;

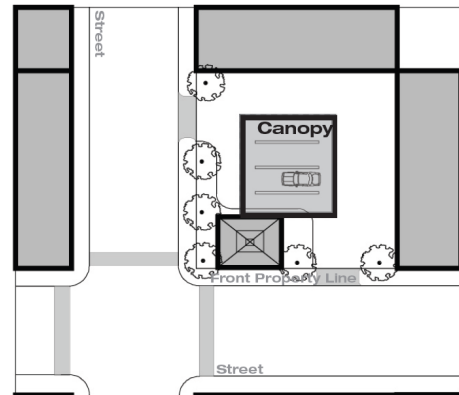
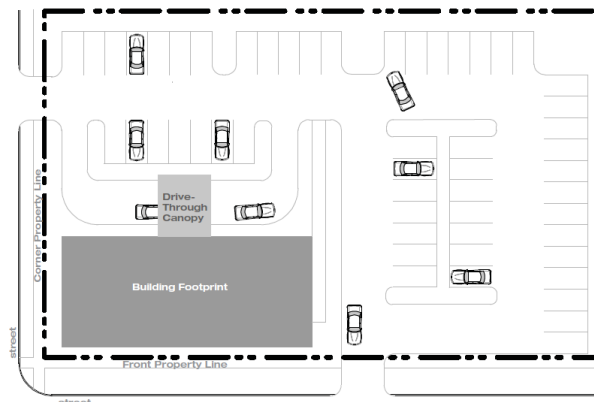

**Figure 50-22.6-A: Relationship between the principal structure and the pump islands**

**C. Drive-through.**

Refer to Figure 50-22.6-B.

1. The drive-through shall be located on the side or rear façade;
2. When occurring adjacent to any residential district, the boundary with those districts shall be buffered in accordance with the standards in Section 50-25.5.B;



**Figure 50-22.6-B: drive-through**

**D. Parking structure.**

Facades of parking structures visible from any public right-of-way shall meet the following requirements:

1. Vertical expression lines are required every 60 feet;
2. Ramped floors shall not be visible from the street. Garage openings shall be organized in stories. Story dimensions shall match adjacent buildings, measured between nine feet and 14 feet floor to floor;
3. The street facing façade surface of the structure shall be articulated with the same level of detail and the same type of material as adjacent buildings. Brick masonry shall be the dominant surface material, occupying a minimum of 50 percent of the street facing façade surface;
4. Garage entries and exits shall be located on secondary streets or alleys. (Ord. No. 10044, 8-16-2010, § 6; cited only by Ord. No. 10284, 3-10-2014, § 2.)

**50-22.7 Building type summary table.**

**Table 50-22.7-1: Building Type Summary Table.**

Type	Street Frontage				Side & Rear Yard Setbacks		Buildable Area	
	Multiple Buildings Permitted on a Lot	Front Yard BTZ or setback (feet)	Corner Side Yard BTZ or setback (feet)	Minimum Coverage of Front Build-to-Zone	Minimum Side Yard Setback (feet)	Minimum Rear Yard Setback (feet)	Minimum Landscape Area	Minimum Lot Width (feet)
Main Street Building I	No	0-15	0-15	65%; BTZ may exclude permitted driveway	0	5	10%	30
Main Street Building II	No	0-5	0-5	95%	0	5	0%	20
Main Street Building III	No	0-5	0-5	95%	0	0	0%	20
Corridor Building I	Yes	5-15	5-15	65%	0	5	10%	30
Corridor Building II	Yes	0-15	0-15	75%	0	5	15%	50
Lakefront Corridor Building	Yes	0-25 BTZ on Lakefront; 0-15 BTZ along Canal Park Drive	0-15	33% on street face; 65% on Lakefront	10% of lot width on each side or aggregate on one side	Not Applicable	20%	50
Corridor Building III	No	0-5	0-5	85%	0	0	0%	50
Cottage Commercial I	Yes	5-20	5-20	60%	5	5	10%	50
Cottage Commercial II	No	0-15	0-15	60%	0	5	20%	50
Iconic	Yes	5' setback	5' setback	Not Applicable	5	5	20%	50

\*1\* Tower permitted for all Building Types;

\*2\* Two driveways may be permitted through Land Use Supervisor approval if frontage exceeds 200';

\*3\* 15 Stories or 188' as measured from W Superior Street, permitted from Mesaba Ave to N 4th Ave E;

\*4\* Ground floor transparency may be greater depending on base type;

Parking & Access		Building Height		Transparency		Entrance	Cap and Base Type	
Location of Parking Facilities (yard)	Number of Permitted Driveways	Minimum Principal Building Height (stories)	Maximum Principal Building Height	Min Front & Corner Side Facade Transparency per Story*4*	Blank Wall Limitations	Primary Entrance Location	Allowed Cap Types*1*	Allowed Base Types
Rear; single or double side aisle permitted	1 driveway permitted per frontage*2*	1	37' along East Superior Street; 45' along London Road	20%	Required	Front or Corner Side Facade	Parapet, Flat Roof, Pitched Roof	Storefront
Rear	If no alley exists, 1 driveway permitted per frontage*2*	1	55'; 80' on Lake Avenue	20%	Required	Front or Corner Side Facade	Parapet, Flat Roof, Pitched Roof	Arcade, Storefront
Rear	If no alley exists, 1 driveway permitted per frontage*5*	1; 2 along Superior Street	80'; 116' on corner parcels only; 188' along Superior Street*3*	20%	Required	Front or Corner Side Facade	Parapet, Flat Roof	Arcade, Storefront
Rear, Single or double side aisle permitted	1 driveway permitted per frontage*2*	1	45'	20%	Required	Front or Corner Side Facade	Parapet, Flat Roof, Pitched Roof	Stoop, Porch
Rear	If no alley exists, 1 driveway permitted per frontage*2*	1	55'; 80' on Lake Avenue	20%	Required	Front or Corner Side Facade	Parapet, Flat Roof, Pitched Roof	Stoop, Porch
Must be screened from the Lakefront by building	1 driveway permitted per every 140' of frontage	1	55'	20%	Required only on street or Lakefront facades	Visible from street	Parapet, Flat Roof, Pitched Roof	Stoop or Porch on Lake or parking lot face; Storefront or Stoop on street face
Rear	If no alley exists, 1 driveway permitted per frontage*5*	1	80'; 116' on corner parcels only; 188' along Superior Street*3*	20%	Required	Front or Corner Side Facade	Parapet, Flat Roof	Stoop
Rear, Single or double side aisle permitted	1 driveway permitted per frontage*2*	1	33'	20%	Not required	Front of Corner Side Facade	Pitched Roof	Shopfront, Porch, Stoop
Rear	If no alley exists, 1 driveway permitted per frontage*2*	1	33'	20%	Not required	Front of Corner Side Facade	Pitched Roof	Shopfront, Porch, Stoop
Rear, Single side aisle permitted	1 driveway permitted per frontage*2*	1	55'	10%	Not required	Front or Corner Side Facade	Parapet, Flat Roof, Pitched Roof	Stoop

(Ord. No 10044, 8-16-2010, Ord. No 10096, 7-18-2011; Ord. No. 10284, 3-10-2014; Ord No. 10522 9-11-2017)

**50-22.8 Main street building I.**

**A. Building Siting**

**1. Street Frontage**

Multiple Principal Buildings	Not permitted
Front Build-to Zone Coverage	65%; BTZ may exclude permitted driveway (a)
Occupation of Corner	Required
Front BTZ	0'to 15' (b)
Corner BTZ	0'to 15' (c)

**2. Building Area**

Side Yard Setback	0' (d)
Rear Yard Setback	5' (e)
Minimum Lot Width	30' (f)
Minimum Landscape Area	10%

**3. Parking Lot, Loading & Access**

Parking Lot Location	Rear yard, Single or double aisle permitted in side yard (g)
Loading Facility Location	Rear or side building facade (h)
Access	1 driveway permitted per frontage, 2 driveways may be permitted through Land Use Supervisor approval if frontage exceeds 200' (i)

**B. Height**

Minimum Overall Height	1 story (j)
Maximum Overall Height	37' along East Superior; 45' along London Road (k)

**C. Uses**

Ground Story	Refer to Article 3. Permitted Uses (l)
Upper Story	Refer to Article 3. Permitted Uses (m)
Parking within Building	Permitted in the rear of the ground floor and fully in any other floor
Occupied Space	30' depth space required on ground floor facing Primary Street (n)

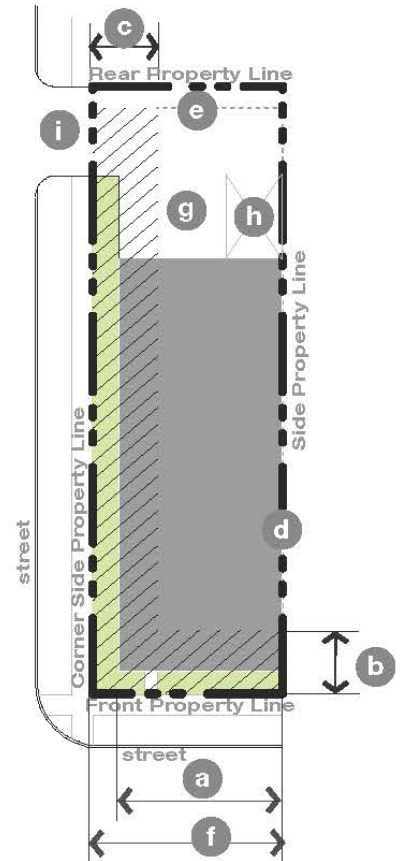



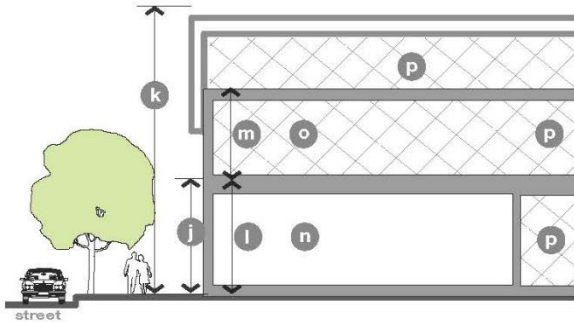

Figure 50-22.8(B): Height & Use Requirements.

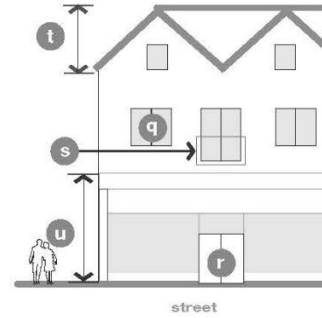

Figure 50-22.8(C): Facade Requirements.

**D. Street Facade Requirements**

1. Transparency (o)

Minimum Transparency	20% per floor
Blank Wall Limitations	Required

2. Building Entrance

Principal Entrance Location	Front or Corner Side Facade of building (p)
Street Facades	No. of Entrances: 1 per 50' of Front Facade

3. Balconies (if provided) (q)

Size	Minimum 3' deep and 5' wide
Facade Coverage	Maximum 30% of front & corner side facades, calculated separately
Access to Balcony	Maximum one (1) dwelling unit
Structure	Independently secured and unconnected to other balconies, or integral to the façade

**E. Cap & Base Type Requirements**

Cap Type	Parapet, Flat Roof, Pitched Roof (r)
Tower	Permitted
Street Facade Base Type	Storefront (s)

(Ord. No. 10044, 8-16-2010, § 6; Ord. No. 10284, 3-10-2014, § 2; Ord No. 10522 9-11-2017)

**50-22.9 Main street building II.**

**A. Building Siting**

**1. Street Frontage**

Multiple Principal Buildings	Not permitted
Front Build-to-Zone Coverage	95% <b>(a)</b>
Occupation of Corner	Required
Front BTZ	0'to 5' <b>(b)</b>
Corner BTZ	0'to 5' <b>(c)</b>

**2. Buildable Area**

Side Yard Setback	0' <b>(d)</b>
Rear Yard Setback	5' <b>(e)</b>
Minimum Lot Width	20' <b>(f)</b>
Minimum Landscape Area	0%

**3. Parking Lot, Loading & Access**

Parking Lot Location	Rear yard (g)
Loading Facility Location	Rear building facade (h)
Access	No driveway permitted if alley access is available; if no alley exists, 1 driveway permitted per frontage; 2 driveways may be permitted through Land Use Supervisor approval if frontage exceeds 200' (i)

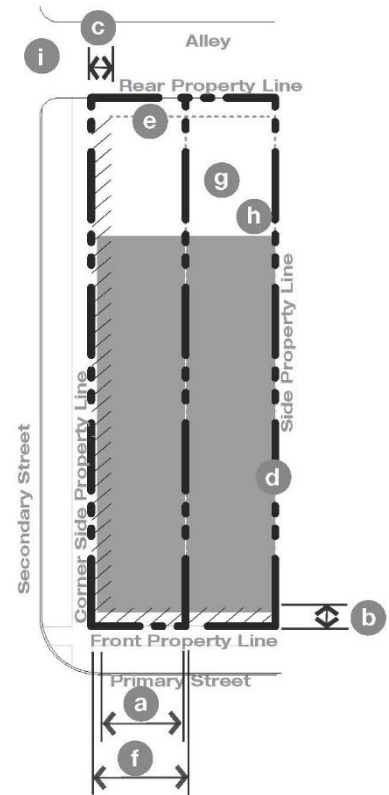

**B. Height**

Minimum Overall Height	1 story <b>(j)</b>
Maximum Overall Height	55'; 80' on Lake Avenue <b>(k)</b>

**C. Uses**

Ground Story	Refer to Article 3. Permitted Uses <b>(l)</b>
Upper Story	Refer to Article 3. Permitted Uses <b>(m)</b>
Parking withing Building	Permitted in the rear of the ground floor and fully in any other floor <b>(n)</b>
Occupied Space	30' depth space required on ground floor facing Primary Street

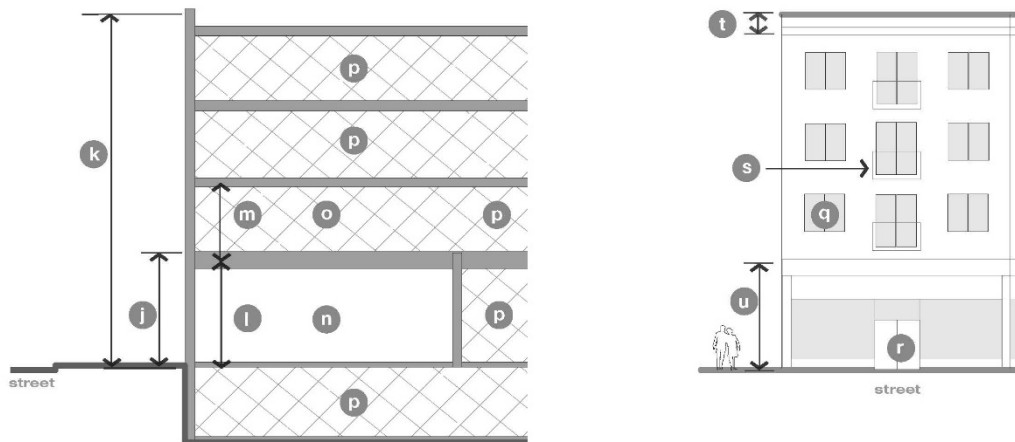

**D. Street Facade Requirements**

**1. Transparency (o)**

Minimum Transparency	20% per floor
Blank Wall Limitations	Required

**2. Building Entrance**

Principal Entrance Location	Front or Corner Side Facade of building (p)
Street Facades	No. of Entrances: 1 per 75' of Front Facade

**3. Balconies (if provided) (q)**

Size	Minimum 3' deep and 5' wide
Facade Coverage	Maximum 30% of front & corner side facades, calculated separately
Access to Balcony	Maximum one (1) dwelling unit
Structure	Independently secured and unconnected to other balconies, or integral to the facade

**E. Cap & Base Type Requirements**

Cap Type	Parapet, Flat Roof, Pitched Roof (r)
Tower	Permitted
Street Facade Base Type	Arcade, Storefront (s)

**F. Facade Materials Requirements<sup>\*2\*</sup>**

Permitted Facade Materials	Durable, natural materials, such as stone, brick, stucco, metal, and concrete
Permitted Upper Story Facade Materials	Painted or Stained Wood
Required Materials	Minimum 60% masonry on each facade, red brick preferred
Materials to Avoid	Imitation materials intended to look like natural materials, Residential grade windows and doors on the ground story; painted brick or stone
Prohibited Materials on Facades	Concrete masonry units, utility or economy bricks more than 3" in height, untreated wood, and exterior insulation & finishing systems (EIFS)
Facade Colors	Historic Paint Palettes by any major brand, also on file at City Hall

<sup>\*2\*</sup> Facade materials requirements apply only to the Canal Park area

(Ord. No. 10044, 8-16-2010, § 6; Ord. No. 10284, 3-10-2014, § 2; Ord No. 10522 9-11-2017)

**50-22.10 Main street building III.**

**A. Building Siting**

**1. Street Frontage**

Multiple Principal Buildings	Not permitted
Front Build-to-Zone Coverage	95% <b>(a)</b>
Occupation of Corner	Required
Front BTZ	0'to 5' <b>(b)</b>
Corner BTZ	0'to 5' <b>(c)</b>

**2. Buildable Area**

Side Yard Setback	0' <b>(d)</b>
Rear Yard Setback	0' <b>(e)</b>
Minimum Lot Width	20' <b>(f)</b>
Minimum Landscape Area	0%

**3. Parking Lot, Loading & Access**

Parking Lot Location	Rear yard <b>(g)</b>
Loading Facility Location	Rear building facade <b>(h)</b>
Access	No driveway permitted if alley access is available; if no alley exists, 1 driveway permitted per frontage; 2 driveways may be permitted through Land Use Supervisor approval if frontage exceeds 300' <b>(i)</b>

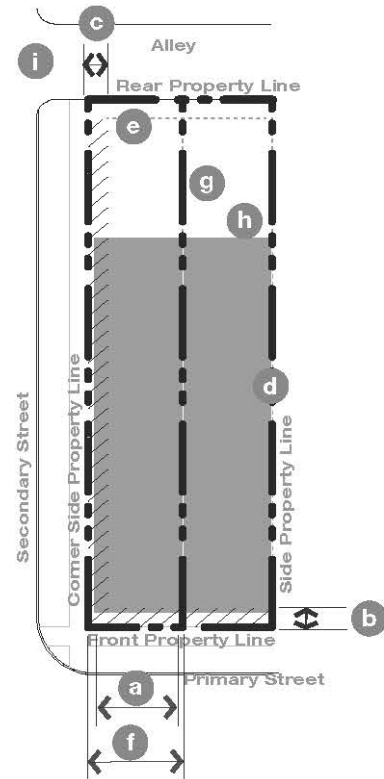

**B. Height**

Minimum Overall Height	1 story; 2 stories along Superior Street <b>(j)</b>
Maximum Overall Height	80; 116' on corner parcels only; 188' along Superior Street *1,2* <b>(k)</b>

**C. Uses**

Ground Story	Refer to Article 3. Permitted Uses <b>(l)</b>
Upper Story	Refer to Article 3. Permitted Uses <b>(m)</b>
Parking withing Building	Permitted in the rear of all floors and fully in any basement <b>(n)</b>
Occupied Space	30' depth & 30' height required facing Primary Streets; 30' depth required on ground floor facing Secondary Streets

<sup>\*\*</sup> 15 stories/188' height shall be measured from Superior

<sup>\*\*</sup> 15 stories permitted from Mesaba Ave to N 4th Ave E on W Superior Street

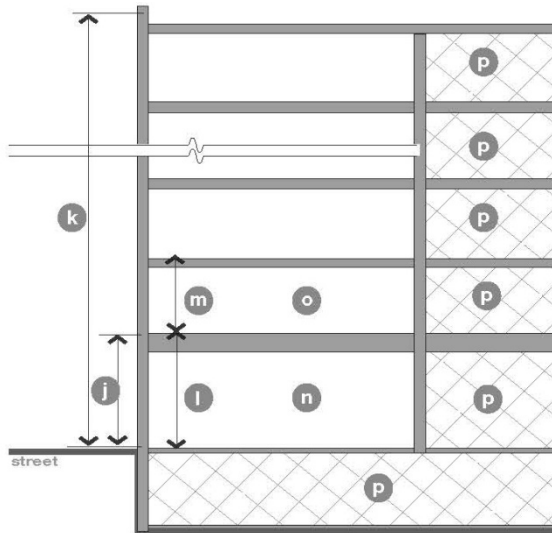

Figure 50-22.10(B): Height & Use Requirements.

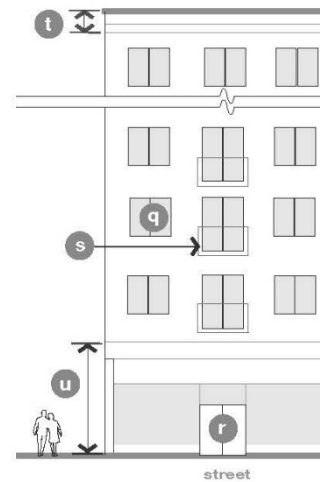

Figure 50-22.10(C): Facade Requirements.

**D. Street Facade Requirements**

1. Transparency (o)

Minimum Transparency	20% per floor
Blank Wall Limitations	Required

2. Building Entrance

Principal Entrance Location	Front or Corner Side Facade of building (p)
Street Facades	No. of Entrances: 1 per 75' of Front Facade

3. Balconies (if provided) (q)

Size	Minimum 3' deep and 5' wide
Facade Coverage	Maximum 30% of front & corner side facades, calculated separately
Access to Balcony	Maximum one (1) dwelling unit
Structure	Independently secured and unconnected to other balconies, or integral to the facade

**E. Cap & Base Type Requirements**

Cap Type	Parapet, Flat Roof (r)
Tower	Permitted
Street Facade Base Type	Arcade, Storefront (s)

(Ord. No. 10044, 8-16-2010, § 6; Ord. No. 10284, 3-10-2014, § 2; Ord No. 10522 9-11-2017)

**50-22.11 Corridor building I.**

**A. Building Siting**

**1. Street Frontage**

Multiple Principal Buildings	Permitted
Front Build-to-Zone Coverage	65% <b>(a)</b>
Occupation of Corner	Required
Front BTZ	5' to 15' <b>(b)</b>
Corner BTZ	5' to 15' <b>(c)</b>

**2. Buildable Area**

Side Yard Setback	0' <b>(d)</b>
Rear Yard Setback	5' <b>(e)</b>
Minimum Lot Width	30' <b>(f)</b>
Minimum Landscape Area	10%

**3. Parking Lot, Loading & Access**

Parking Lot Location	<b>(g)</b> Rear yard; Single or double aisle permitted in side yard <b>(h)</b>
Loading Facility Location	Rear or side building facade
Access	1 driveway permitted per frontage; 2 driveways may be permitted through Land Use Supervisor approval if frontage exceeds 200' <b>(i)</b>

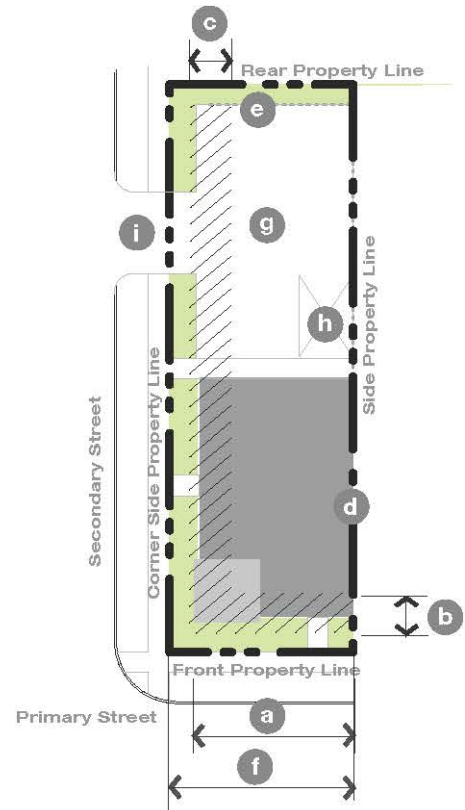

**B. Height**

Minimum Overall Height	1 story <b>(j)</b>
Maximum Overall Height	45' <b>(k)</b>

**C. Uses**

Ground Story	Refer to Article 3. Permitted Uses <b>(l)</b>
Upper Story	Refer to Article 3. Permitted Uses <b>(m)</b>
Parking within Building	Permitted in the rear of the ground floor and fully in any other floor <b>(n)</b>
Occupied Space	30' depth space required on ground floor facing Primary Street

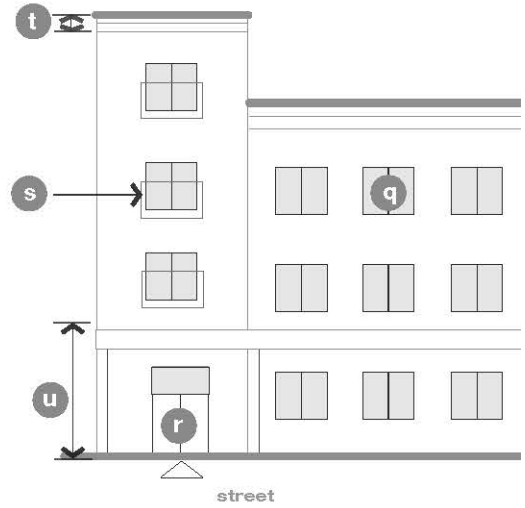
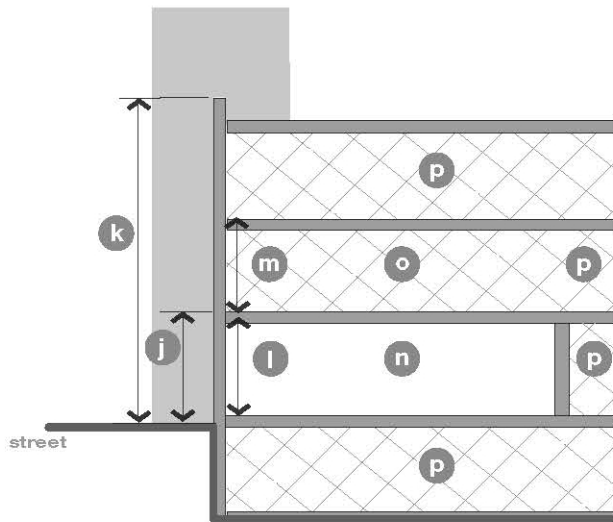

**D. Street Facade Requirements**

1. Transparency

Minimum Transparency	20% per floor (o)
Blank Wall Limitations	Required

2. Building Entrance

Principal Entrance Location	Front or Corner Side Facade of building (p)
Street Facades	No. of Entrances: 1 per 50' of Front Facade

3. Balconies (if provided) (q)

Size	Minimum 3' deep and 5' wide
Facade Coverage	Maximum 30% of front & corner side facades, calculated separately
Access to Balcony	Maximum one (1) dwelling unit
Structure	Independently secured and unconnected to other balconies, or integral to the facade

**E. Cap & Base Type Requirements**

Cap Type	Parapet, Flat Roof, Pitched Roof (r)
Tower	Permitted
Street Facade Base Type	Stoop, Porch <sup>2</sup> (s)

<sup>2</sup> Porch, Stoop, or stairs may encroach to within 2' of the property line

(Ord. No. 10044, 8-16-2010, § 6; Ord. No. 10284, 3-10-2014, § 2; Ord No. 10522 9-11-2017)

**50-22.12 Corridor building II.**

**A. Building Siting**

**1. Street Frontage**

Multiple Principal Buildings	Permitted
Front Build-to Zone Coverage	75%
Occupation of Corner	Required <b>(a)</b>
Front BTZ	0' to 15' <b>(b)</b>
Corner BTZ	0' to 15' <b>(c)</b>

**2. Building Area**

Side Yard Setback	0' <b>(d)</b>
Rear Yard Setback	5' <b>(e)</b>
Minimum Lot Width	50' <b>(f)</b>
Minimum Landscape Area	15%

**3. Parking Lot, Loading & Access**

Parking Lot Location	Rear yard <b>(g)</b>
Loading Facility Location	Rear building facade <b>(h)</b>
Access	No driveway permitted if alley access is available; If no alley exists, 1 driveway permitted per frontage; 2 driveways may be permitted through (special exception) if frontage exceeds 200' <b>(i)</b>

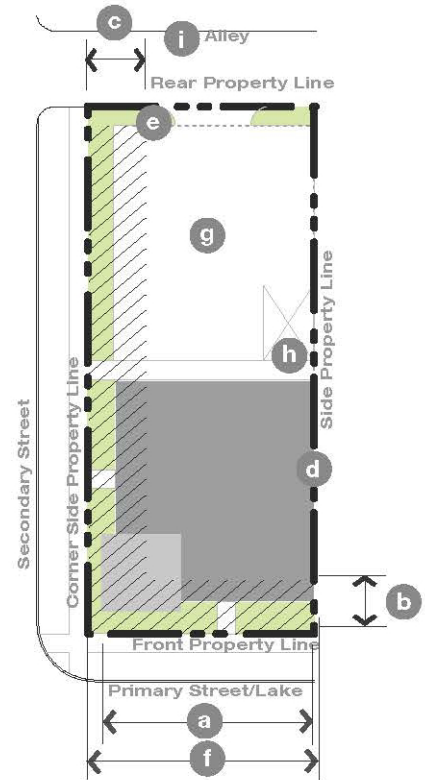

**B. Height**

Minimum Overall Height	1 story <b>(j)</b>
Maximum Overall Height	55'; 80' on Lake Avenue <b>(k)</b>

**C. Uses**

Ground Story	Refer to Article 3. Permitted Uses <b>(l)</b>
Upper Story	Refer to Article 3. Permitted Uses <b>(m)</b>
Parking within Building	Permitted in the rear of the ground floor and fully in any other floor <b>(n)</b>
Occupied Space	30' depth space required on ground floor facing Primary Street



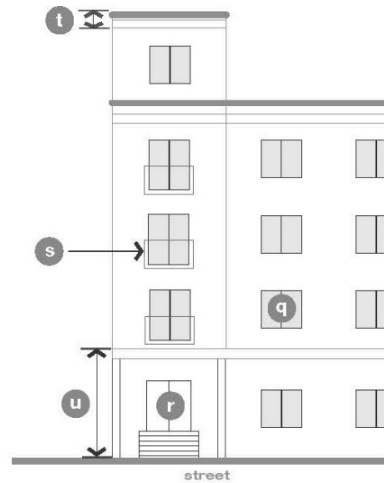
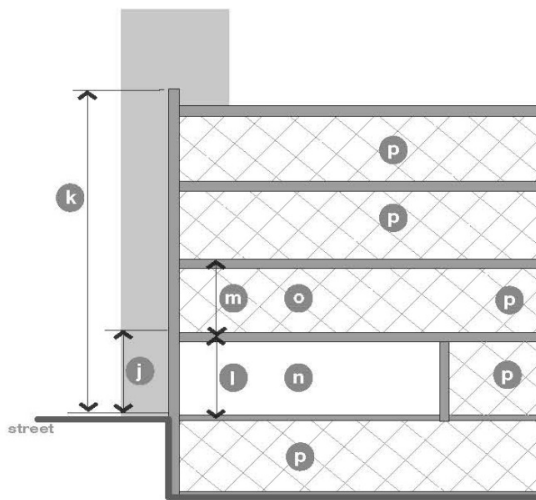

**D. Street Facade Requirements**

**1. Transparency (o)**

Minimum Transparency	20% per floor
Blank Wall Limitations	Required

**2. Building Entrance**

Principal Entrance Location	Front or Corner Side Facade of building (p)
Street Facades	No. of Entrances: 1 per 75' of Front Façade

**3. Balconies (if provided) (q)**

Size	Minimum 3' deep and 5' wide
Facade Coverage	Maximum 30% of front & corner side facades, calculated separately
Access to Balcony	Maximum one (1) dwelling unit
Structure	Independently secured and unconnected to other balconies, or integral to the facade

**E. Cap & Base Type Requirements**

Cap Type	Parapet, Flat Roof, Pitched Roof (r)
Tower	Permitted
Street Facade Base Type	Stoop, Porch (s)

**F. Facade Materials Requirements<sup>2\*</sup>**

Permitted Facade Materials	Durable, natural materials, such as stone, brick, stucco, metal, & concrete
Permitted Upper Story Facade Materials	Painted or Stained Wood
Required Materials	Minimum 60% masonry on each facade, red brick preferred
Materials to Avoid	Imitation materials intended to look like natural materials; Residential grade windows & doors on the ground story; painted brick or stone
Prohibited Materials on Facades	Concrete masonry units, utility or economy bricks more than 3" in height, untreated wood, & exterior insulation & finishing systems (EIFS)
Facade Colors	Historic Paint Palettes by any major brand, also on file at City Hall

<sup>2\*</sup> Facade materials requirements apply only to the Canal Park

(Ord. No. 10044, 8-16-2010, § 6; Ord. No. 10284, 3-10-2014, § 2; Ord No. 10522 9-11-2017)

**50-22.13 Lakefront corridor building.**

**A. Building Siting**

**1. Street & Lake Frontage**

Multiple Principal Buildings	Permitted
Build-to-Zone Coverage:	
Front & Corner BTZ	33% (a)
Rear BTZ on Lakefront	65% (b)
Occupation of Corner	Required
Build-to-Zone:	
Front & Corner BTZ on Street Face	0-15' (c)
Rear BTZ on Lakefront	0-25' (d)

**2. Buildable Area**

Side Yard Setback	10% of lot width on each side or aggregate on one side (e)
Rear Yard Setback	Not applicable
Lakefront Access Easement	Minimum 50' wide easement from Canal Park Drive to the Lakewalk <sup>11</sup> *
Minimum Lot Width	50' (f)
Minimum Landscape Area	20%

**3. Parking Lot, Loading & Access**

Parking Lot Location	Must be screened from the Lakefront by building (g)
Loading Facility Location	Not permitted on Street per Lakefront Facades (h)
Access	1 driveway permitted per every 140' of street frontage (i)

**B. Height**

Minimum Overall Height	1 story (j)
Maximum Overall Height	55' (k)

**C. Uses**

Ground Story	Refer to Article 3. Permitted Uses (l)
Upper Story	Refer to Article 3. Permitted Uses (m)
Parking within Building	Permitted in the rear of the ground floors and fully in any basement (n)
Occupied Space	30' depth space facing Primary Street or space on front façade

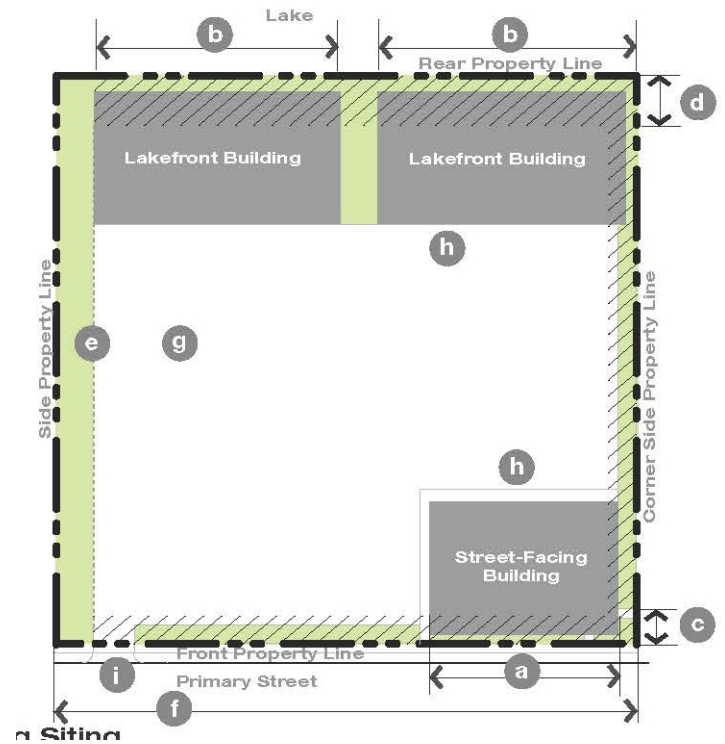

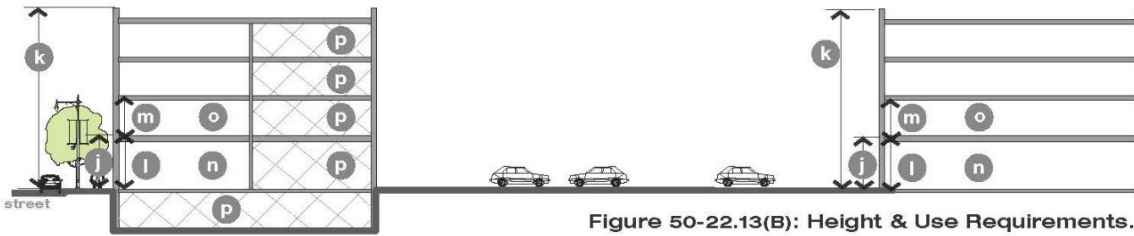
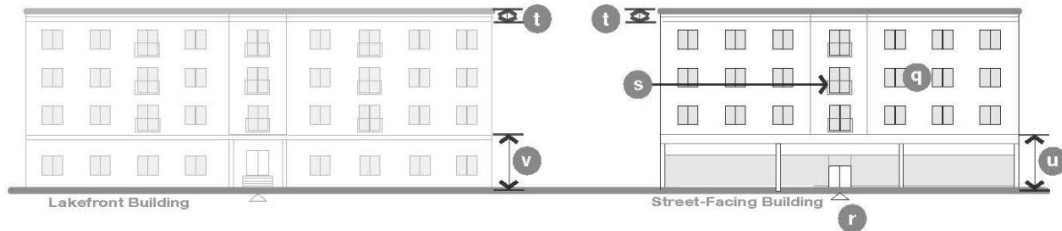

Figure 50-22.13(B): Height & Use Requirements.



**D. Street, Lakefront, & Parking Lot Facade Requirements**

1. Transparency (o)
  - Minimum Transparency 20% per floor
  - Blank Wall Limitations Required only on Street & Lakefront Facades
2. Building Entrance
  - Principal Entrance Location Visible from Street (p)
  - Street Facades No. of Entrances 1 per 100' of Front Facade
  - Lakefront Facade 1 per 150' of Front Facade
3. Balconies (if provided) (q)
  - Size Minimum 3' deep and 5' wide
  - Facade Coverage Maximum 30% of front & corner side facades, calculated separately
  - Access to Balcony Maximum one (1) dwelling unit
  - Structure Independently secured and unconnected to other balconies, or integral to the facade

**E. Cap & Base Type Requirements**

- Cap Type Parapet, Flat Roof, Pitched Roof (r)
- Tower Permitted
- Street Facade Base Type Storefront, Stoop (s)
- Parking Lot Facade Base Type Visible from Street Stoop, Porch (t)
- Lakefront Facade Base Type Stoop, Porch (t)

**F. Facade Materials Requirements**

- Permitted Facade Materials Durable, natural materials, such as stone, brick, stucco, metal, & concrete
- Permitted Upper Story Facade Materials Painted or stained wood
- Materials to Avoid Imitation materials intended to look like natural materials; Residential grade windows & doors on the ground story; painted brick or stone
- Prohibited Materials on Facades Concrete masonry units, utility or economy bricks more than 3" in height, untreated wood, & exterior insulation & finishing systems (EIFS)
- Facade Colors Historic Paint Palettes by any major brand, also on file at City Hall  
(Ord. No. 10044, 8-16-2010, § 6; Ord. No. 10284, 3-10-2014, § 2; Ord No. 10522 9-11-2017)

**50-22.14 Corridor building III.**

**A. Building Siting**

1. Street Frontage

Multiple Principal Buildings	Not Permitted
Front Build-to Zone Coverage	85% <b>(a)</b>
Occupation of Corner	Required
Front BTZ	0' to 5' <b>(b)</b>
Corner BTZ	0' to 5' <b>(c)</b>

2. Buildable Area

Side Yard Setback	0' <b>(d)</b>
Rear Yard Setback	0' <b>(e)</b>
Minimum Lot Width	50' <b>(f)</b>
Minimum Landscape Area	0%

3. Parking Lot, Loading & Access

Parking Lot Location	Rear Yard <b>(g)</b>
Loading Facility Location	Rear Building Facades <b>(h)</b>
Access	No driveway permitted if alley is available; if no alley exists; 1 driveway permitted per frontage; 2 driveways may be permitted through Land Use Supervisor approval if frontage exceeds 300' <b>(i)</b>

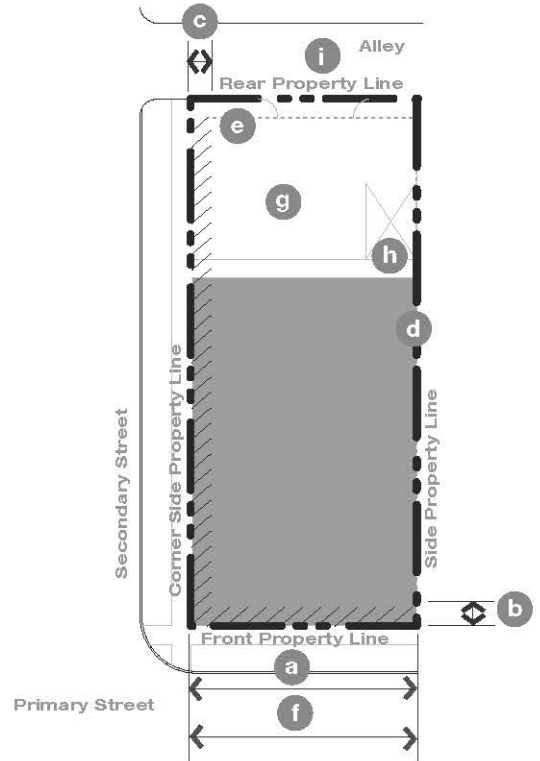

**B. Height**

Minimum Overall Height	1 story <b>(j)</b>
Maximum Overall Height	80'; 116' on corner parcels only; 188' along Superior street <sup>1 2*</sup> <b>(k)</b>

**C. Uses**

Ground Story	Refer to Article 3. Permitted Uses <b>(l)</b>
Upper Story	Refer to Article 3. Permitted Uses <b>(m)</b>
Parking within Building	Permitted in the rear of all floors and fully in any basement <b>(n)</b>
Occupied Space	30' depth & 30' height required facing Primary Streets; 30' depth required on ground floor facing Secondary Streets

<sup>1</sup>15 Stories/188' height shall be measured from Superior Street

<sup>2</sup> 15 Stories permitted from Mesaba Ave to N 4th Ave E on W Superior Street

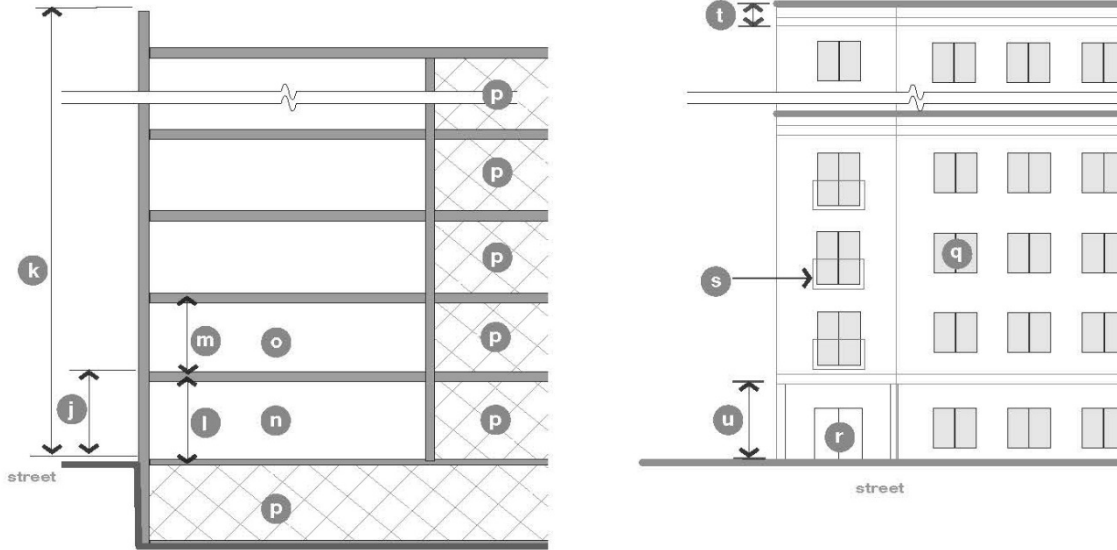

**D. Street Facade Requirements**

1. Transparency (o)

Minimum Transparency	20% per floor
Blank Wall Limitations	Required

2. Building Entrance (p)

Principal Entrance Location	Front or Corner Side Facade of Building
Street Facades	No. of Entrances: 1 per 75' of Front Facade

3. Balconies (if provided) (q)

Size	Minimum 3' deep and 5' wide
Facade Coverage	Maximum 30% of front & corner side facades, calculated separately
Access to Balcony	Maximum one (1) dwelling unit
Structure	Independently secured and unconnected to other balconies, or integral to the facade

**E. Cap & Base Type Requirements**

Cap Type	Parapet, Flat Roof (r)
Tower	Permitted
Street Facade Base Type	Stoop (s)

(Ord. No. 10044, 8-16-2010, § 6; Ord. No. 10284, 3-10-2014, § 2; Ord No. 10522 9-11-2017)

**50-22.15 Cottage Commercial I.**

**A. Building Siting**

**1. Street Frontage**

Multiple Principal Buildings	Permitted** (a)
Front Build-to Zone Coverage	60% (b)
Occupation of Corner	Required
Front BTZ	5' to 20' (c)
Corner BTZ	5' to 20' (d)

**2. Buildable Area**

Side Yard Setback	5' (e)
Rear Yard Setback	5' (f)
Minimum Lot Width	50' (g)
Minimum Landscape Area	10%

**3. Parking Lot, Loading & Access**

Parking Lot Location	Rear Yard, Single or double (h)
Loading Facility Location	Rear or side building facade (i)
Access	1 driveway permitted per frontage; 2 driveways may be permitted through Land Use Supervisor approval if frontage exceeds 200' (j)

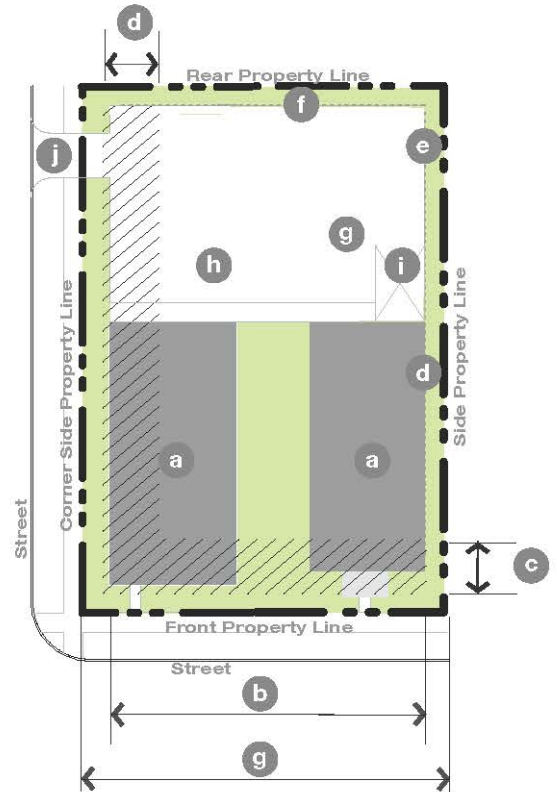

**B. Height**

Minimum Overall Height	1 story (k)
Maximum Overall Height	33' (j)

**C. Uses**

Ground Story	Refer to Article 3. Permitted Uses (m)
Upper Story	Refer to Article 3. Permitted Uses (n)
Parking within Building	Permitted in the rear of all floors and fully in any basement (o)
Occupied Space	30' depth space facing Primary Streets; façade

\*\*Each principal building shall have a width of less than 75' & meet the applicable requirements for the Building Type included in this Section

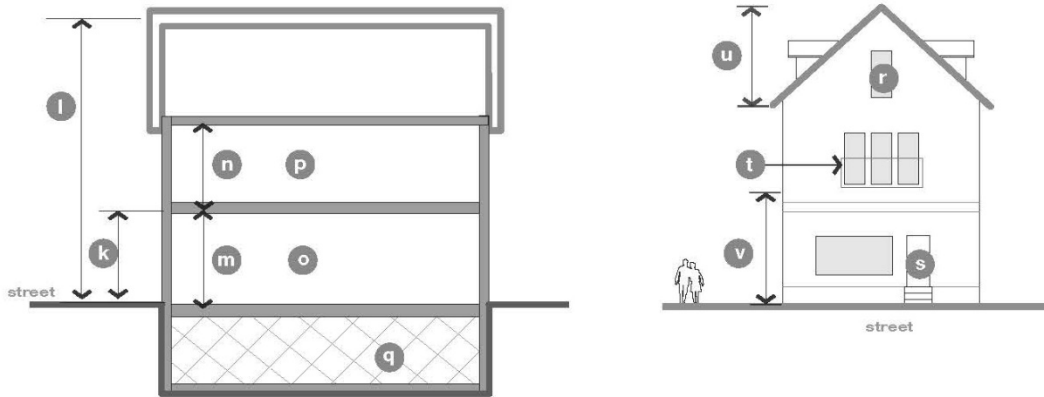

**D. Street Facade Requirements**

1. Transparency (p)

Minimum Transparency	20% per floor
Blank Wall Limitations	Required

2. Building Entrance

Principal Entrance Location	Front or Corner Side Facade of Building (q)
Street Facades	No of Entrances: Not Required

3. Balconies (if provided) (r)

Size	Minimum 3' deep and 5' wide
Facade Coverage	Maximum 30% of front & corner side facades, calculated separately
Access to Balcony	Maximum one (1) dwelling unit
Structure facade	Independently secured and unconnected to other balconies, or integral to the facade

**E. Cap & Base Type Requirements**

Cap Type	Pitched Roof (s)
Tower	Permitted
Street Facade Base Type	Shopfront, Porch, Stoop <sup>*3*</sup> (t)

(Ord. No. 10044, 8-16-2010, § 6; Ord. No. 10284, 3-10-2014, § 2; Ord No. 10522 9-11-2017)

<sup>\*3\*</sup>Porch, Stoop or stairs may encroach to within 2' of the property line

**50-22.16 Cottage commercial II.**

**A. Building Siting**

**1. Street Frontage**

Multiple Principal Buildings	Not Permitted
Front Build-to Zone Coverage	60% <b>(a)</b>
Occupation of Corner	Required
Front BTZ	0' to 15' <b>(b)</b>
Corner BTZ	0' to 15' <b>(c)</b>

**2. Buildable Area**

Side Yard Setback	0' <b>(d)</b>
Rear Yard Setback	5' <b>(e)</b>
Minimum Lot Width	50' <b>(f)</b>
Minimum Landscape Area	20%

**3. Parking Lot, Loading & Access**

Parking Lot Location	Rear Yard <b>(g)</b>
Loading Facility Location	Rear building facade <b>(h)</b>
Access	No driveway permitted if alley access is available; If no alley exists, 1 driveway permitted per frontage; 2 driveways may be permitted through Land Use Supervisor approval if frontage exceeds 200' <b>(i)</b>

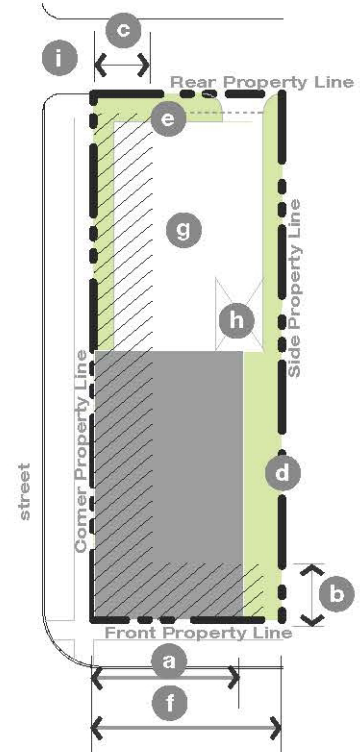

**B. Height**

Minimum Overall Height	1 story <b>(j)</b>
Maximum Overall Height	33' <b>(k)</b>

**C. Uses**

Ground Story	Refer to Article 3. Permitted Uses <b>(l)</b>
Upper Story	Refer to Article 3. Permitted Uses <b>(m)</b>
Parking within Building	Permitted in the rear of all floors and fully in any basement <b>(n)</b>
Occupied Space	30' depth space facing Primary Streets or space on front façade



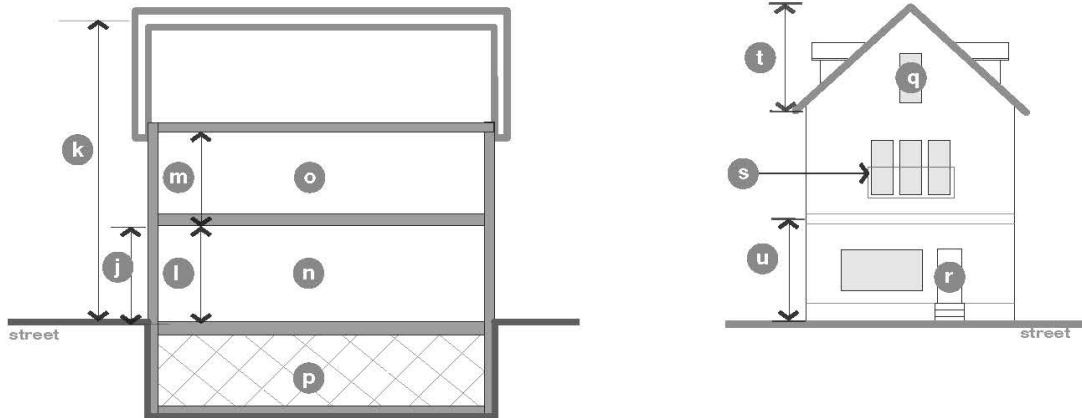

**D. Street Facade Requirements**

1. Transparency (o)

Minimum Transparency	20% per floor
Blank Wall Limitations	Not Required

2. Building Entrance

Principal Entrance Location	Front or Corner Side Facade of Building (p)
Street Facades	No. of Entrances: Not Required

3. Balconies (if provided) (q)

Size	Minimum 3' deep and 5' wide
Facade Coverage	Maximum 30% of front & corner side facades, calculated separately
Access to Balcony	Maximum one (1) dwelling unit
Structure	Independently secured and unconnected to other balconies, or integral to the facade

**E. Cap & Base Type Requirements**

Cap Type	Pitched Roof (r)
Tower	Permitted
Street Facade Base Type	Shopfront, Porch, Stoop (s)

(Ord. No. 10044, 8-16-2010, § 6; Ord. No. 10284, 3-10-2014, § 2; Ord No. 10522 9-11-2017)

**50-22.17 Iconic building.**

**A. Building Siting**

**1. Street Frontage**

Multiple Principal Buildings	Permitted
Front Build-to Zone Coverage	Not Applicable
Occupation of Corner	Not Required
Front BTZ	5' <b>(a)</b>
Corner BTZ	5' <b>(b)</b>

**2. Buildable Area**

Side Yard Setback	5' <b>(c)</b>
Rear Yard Setback	5' <b>(d)</b>
Minimum Lot Width	50' <b>(e)</b>
Minimum Landscape Area	20%

**3. Parking Lot, Loading & Access**

Parking Lot Location	Rear Yard; Single aisle permitted in side yard <b>(f)</b>
Loading Facility Location	Rear building facade <b>(g)</b>
Access	1 driveway permitted per frontage; 2 driveways may be permitted through Land Use Supervisor approval if frontage exceeds 200' <b>(h)</b>

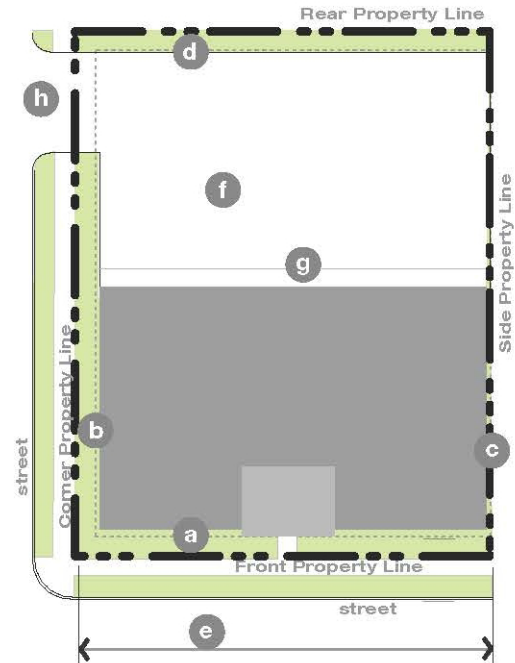

**B. Height**

Minimum Overall Height	1 story <b>(i)</b>
Maximum Overall Height	55' <b>(j)</b>

**C. Uses**

Ground & Upper Stories	Only Civic, Institutional, Utility, & Recreation uses are permitted in the Iconic Building Type. Local designated historic landmarks are exempt from this requirement <b>(k)</b>
Parking within Building	Permitted in the rear of all floors and fully in any basement
Occupied Space	30' depth space facing Primary Streets or space on front façade

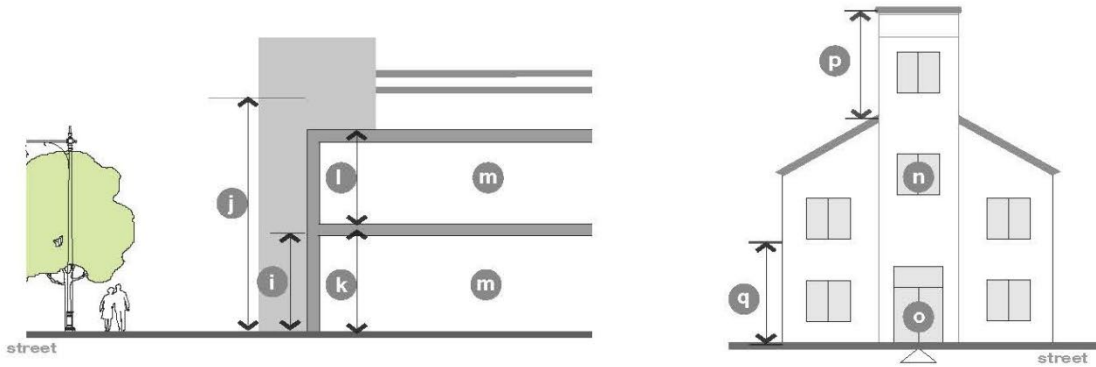

**D. Street Facade Requirements**

1. Transparency (I)

Minimum Transparency	10% per floor
Blank Wall Limitations	Not Required

2. Building Entrance

Principal Entrance Location	Front or Corner Side Facade of Building (m)
Street Facades	No. of Entrances: Not Required

**E. Cap & Base Type Requirements**

Cap Type <sup>2*</sup>	Parapet, Pitched Roof, Flat Roof (n)
Tower	Permitted
Street Facade Base Type	Stoop (o)

(Ord. No. 10044, 8-16-2010, § 6; Ord. No. 10284, 3-10-2014, § 2; Ord No. 10522 9-11-2017)

<sup>2\*</sup>Other cap types not listed here may be approved by the Land Use Supervisor



## 50-23 CONNECTIVITY AND CIRCULATION.

### 50-23.1 Applicability and exemptions.

This Section 50-23 shall apply to all new subdivision, replatting, registered land surveys (RLSs), development and redevelopment applications after November 19, 2010. General circulation requirements are listed in Section 50-23.2, but additional circulation requirements apply in some circumstances. Sites that are (a) located in any zone district other than the RC, RR-1, RR-2, MU-B, I-G, or I-W districts, and (b) larger than three acres, and (c) will contain more than one development parcel shall meet the connectivity index requirements of Section 50-23.3. All new subdivision, replatting, development, and redevelopment applications shall meet the requirements of Section 50-23.4, and those containing more than one principal building shall meet the requirements of Section 50-23.5. (Ord. No. 10044, 8-16-2010, § 6.)

### 50-23.2 General circulation requirements.

Applications for subdivision, replatting, RLS, development, or redevelopment shall meet the following standards:

- A. Where adopted city plans show a bicycle or pedestrian path or trail or sidewalk, the site design shall provide connections to those paths or trails or sidewalks;
- B. Any requests by the city for designation or dedication of land for bicycle or pedestrian trails within a proposed development shall comply with the provisions of Section 50-33.8, *Land for public purposes*;
- C. Unless the city engineer waives the requirement in writing based on concerns of public safety, or site/ topography constraints:
  1. Each proposed street within a new subdivision, regardless of zoning designation, shall be public and designed and constructed to city engineer construction standards;
  2. Each proposed public or private street within the R-1, R-2, R-P, MU-P, MU-N, MU-C, MU-I or MU-W districts shall include a sidewalk at least five feet wide or a multi-use trail at least eight feet wide on at least one side of the street, as determined by the City Engineer. The sidewalk or multi-use trail shall be set back from the edge of curb by at least five feet to allow room for snow storage and/or landscape features;
  3. Each proposed public or private street within the MU-B, I-G or I-W districts shall include a sidewalk at least five feet wide or a multi-use trail at least eight feet wide on one side of the street;
  4. Proposed public or private sidewalk and multi-use trails shall use the most direct path practical;

D. Whenever cul-de-sac streets are created, one ten foot wide pedestrian access/public utility easement shall be provided, between the cul-de-sac head or street turnaround and the sidewalk system of the closest adjacent street or pedestrian sidewalk or pathway, unless the city engineer determines that public access in that location is not practicable due to site or topography constraints (refer to Figure 50-23-A);

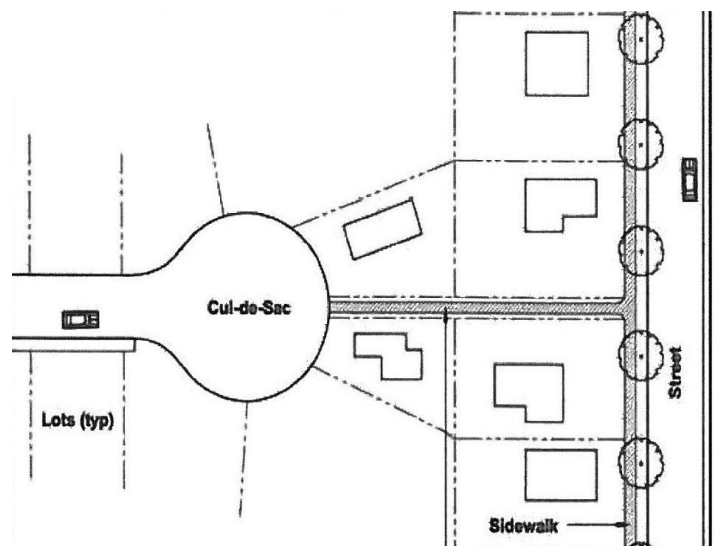

Figure 50-23-A: 10 ft. access easement from head of cul-de-sac to nearest street or path

E. A pedestrian way at least ten feet in width shall be provided near the middle of any block face longer than 800 feet in order to provide connections with streets on either side of the block;

F. Any use requiring vehicle access from a public street or alley shall be referred to the city engineer for review before any permits are issued. The city engineer shall consider, but not be limited to, the following factors when determining whether to approve the proposal:

1. The consolidation of curb cuts shall be encouraged, and new curb cuts shall be discouraged whenever appropriate, considering safe traffic flow, the objectives of this chapter, and access points needed for the proper function of the use;
2. Functional classification of the road where the curb cut is proposed;
3. The location of driveways shall be at least 100 feet from an intersection. The city engineer may permit driveways closer to an intersection due to limited lot frontage or site/topography constraints;
4. The location of driveways relative to other existing uses is such that street traffic shall not be seriously disrupted and no unnecessary hazards shall be established for pedestrians. (Ord. No. 10044, 8-16-2010, § 6; Ord. No. 10096, 7-18-2011, § 25; Ord. No. 10458, 7-11-2016, § 1; Ord. No. 10733, 1-11-2021, § 4)

### **50-23.3 Connectivity index for larger non-exempt developments.**

---

#### **A. Requirements.**

1. A connectivity index is calculated by dividing the number of "links" in the proposed development by the number of "nodes" in the same development;
2. In order to promote walkability and reduce the number and length of vehicular trips both within developments and between new developments and surrounding areas, each development or redevelopment covered by this Section 50-23 shall provide internal junctions and external connections to achieve a connectivity index calculation of at least 1.65;
3. In addition, each street frontage of the development shall include at least one street stub or connection to the external street system every 1,500 feet;
4. The land use supervisor may reduce the required connectivity index, the requirement for external street connections, or the requirement for cul-de-sac access easements if compliance with the provisions of this subsection is impracticable due to site or topography constraints;

## B. Example.

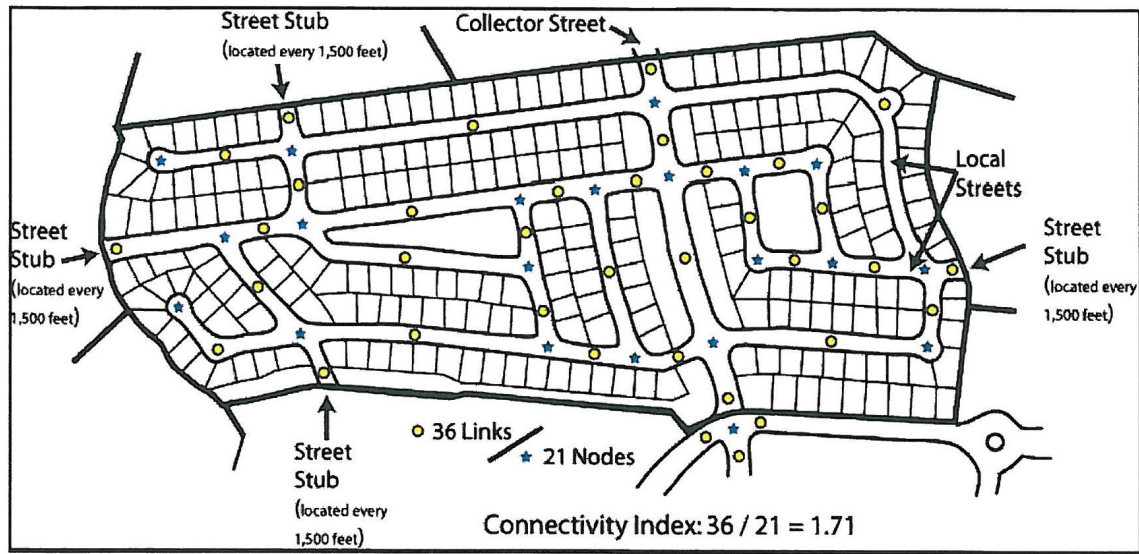

Figure 50-23-B: Example: There are 36 links (circles) and 21 nodes (stars).

(Ord. No. 10044, 8-16-2010, § 6.)

#### 50-23.4 Americans with Disabilities Act.

All "places of public accommodation," as defined in the federal Americans with Disabilities Act (42 U.S.C. 12101 et. seq.) shall comply with the requirements of that act concerning on-site circulation and access. (Ord. No. 10044, 8-16-2010, § 6.)

#### 50-23.5 Multi-building developments.

Commercial developments containing more than one principal building on a single lot or parcel shall include an unobstructed walkway or pathway providing access between the principal buildings. The walkway or pathway shall be at least five feet wide. (Ord. No. 10044, 8-16-2010, § 6.)

#### 50-23.6 Skywalks.

- A. The location and design of skywalks should not compromise the historic or architectural integrity of existing buildings;
- B. Design of skywalks shall be approved based on their architectural sensitivity, harmony and cohesiveness with the historic/industrial waterfront character of the surrounding area;
- C. New skywalks installed and existing sidewalks remodeled at a cost of more than 50 percent of their assessed value after November 19, 2010, shall be designed so that 66 percent of each vertical side elevation is made of glass or transparent materials. A lower level of transparency can be reduced, but not to less than 50 percent, if a higher level of transparency is technically infeasible due to span length and engineering limitations. (Ord. No. 10044, 8-16-2010, § 6.)

**50-23.7 Safe routes to school**

---

Any subdivision approved by the City of Duluth on or after January 1, 2019, shall incorporate Safe Routes to School Infrastructure where applicable. (Ord. No. 10592, 9-24-18, § 1)



## 50-24 PARKING AND LOADING.

### 50-24.1 Applicability.

The standards of this Section 50-24 shall apply to all development and redevelopment, except that:

1. Development and redevelopment in any of the form districts shall only be required to provide that amount of parking that can be accommodated on the development parcel while allowing the principal building to meet all of the building form standards in Section 50-22;
2. No off-street parking shall be required for any non-residential use on a lot smaller than 10,000 square feet in any mixed use district or special purpose district;
3. No off-street parking shall be required for any building with less than 10,000 square feet of gross floor area and with a non-residential primary use in any mixed use district or special purpose district;
4. No off-street parking shall be required within the boundaries of the Downtown area shown in Exhibit 50-24.1-1;
5. No off street parking shall be required for any use except (1) hotels or motel, and (2) residential developments with more than ten units, within the boundaries of the Canal Park area shown in Exhibit 50-24.1-1;
6. Development and redevelopment that is exempt from being required to provide off-street parking but does provide parking, must follow all the provisions of this Section.

(Ord. No. 10044, 8 16 2010, § 6; Ord. No. 10096, 7 18 2011, § 26.)

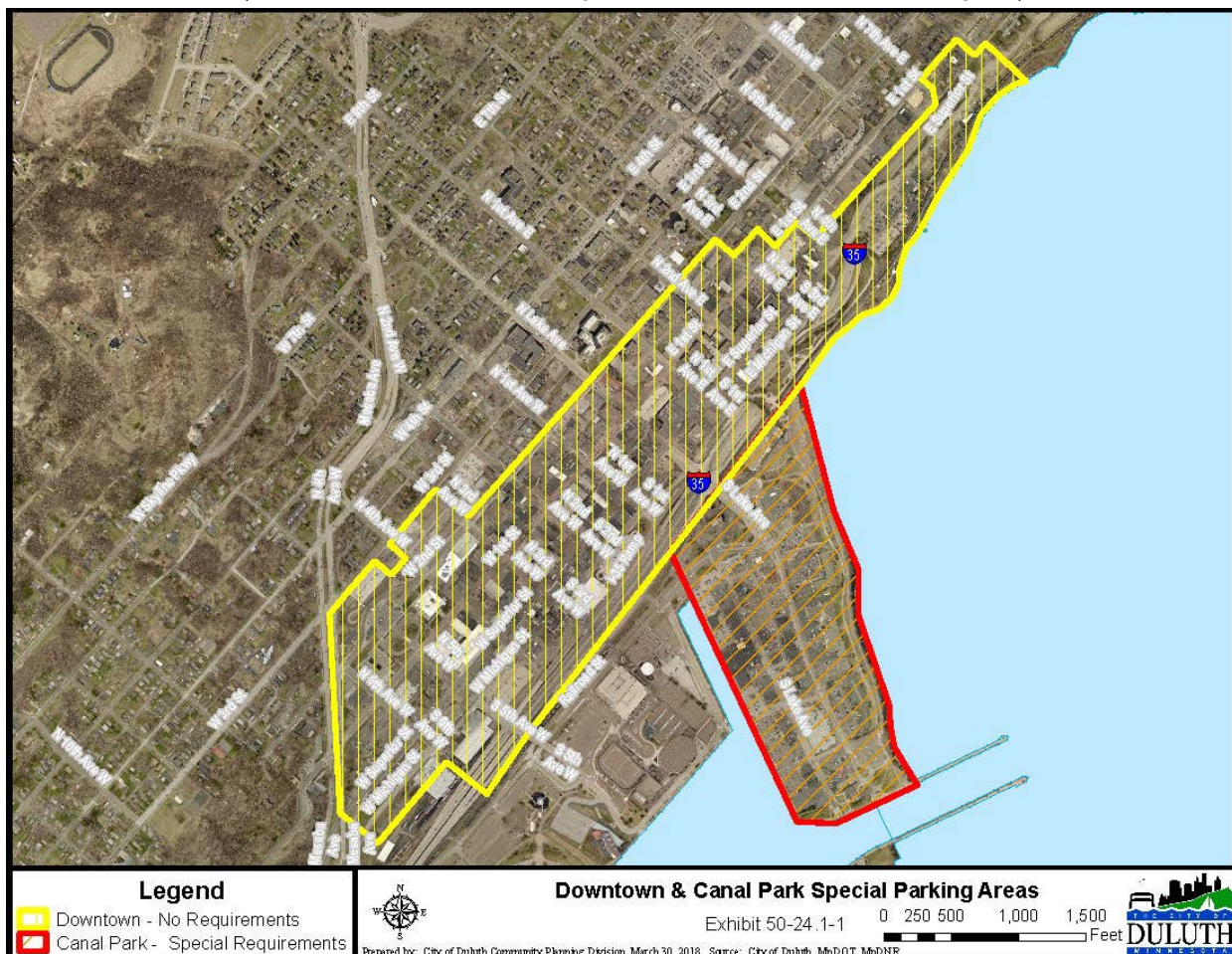

**50-24.2 Required parking spaces.**

In all districts there shall be provided, at the time any building or structure is erected, except as provided in Section 50-24.5, *Calculation of parking spaces*, the number of off-street parking spaces shown in Table 50-24-1, unless an exemption from or variation of this requirement is provided in another section of this Chapter.

<b>Table 50-24-1: Off-Street parking Spaces Required</b>	
<b>Use</b>	<b>Requirement* (May Be Adjusted to 30% Less or 50% More)</b>
<b>RESIDENTIAL USES</b>	
Dwelling, one-family	1 space per dwelling unit
Dwelling, two-family	
Dwelling, townhouse	
Dwelling, live-work	
Co-housing facility	
Manufactured home park	
Dwelling, multi-family	1.25 space per dwelling unit
Assisted living facility (elderly)	1 space per 3 habitable units
Residential care facility	1 space per 6 residential care beds, but not less than 2 spaces
Sober house	1 space per 6 single occupancy beds, but not less than 2 spaces
Rooming house	1 space per habitable unit
<b>PUBLIC, INSTITUTIONAL AND CIVIC USES</b>	
Bus or rail transit station	No requirement
Business, art, or vocational school	1 parking space for each 8 seats in the main auditorium or 3 spaces for each classroom, whichever is greater
Cemetery or mausoleum	No requirement
Club or lodge (private)	2.5 spaces per 1,000 sq. ft. of floor area
Government building or public safety facility	As determined by land use supervisor based on anticipated use and neighborhood impacts
Hospital	2 spaces per 1,000 sq. ft.
Medical or dental clinic	4 spaces per 1,000 sq. ft. of gross floor area
Museum, library or art gallery	1 space per 1,000 sq. ft. of gross floor area
Nursing home	1 space per 6 beds
Park, playground or forest reserve	No requirement
Religious assembly	1 space per 4 seats or per 100 sq. ft. in main auditorium, whichever is greater
School, elementary	1 parking space for each 10 seats in the auditorium or main assembly room or 1 space for each classroom, whichever is greater
School, middle	1 parking space for each 8 seats in the main auditorium or 3 spaces for each classroom, whichever is greater
School, high	5 parking spaces for each classroom or 1.5 parking spaces per 1,000 square feet, whichever is greater
University or college	2 spaces per 1,000 sq. ft. of office, research and library area plus 1 space per 125 sq. ft. of auditorium space.
Other community facility or institutional support uses not listed	As determined by land use supervisor based on anticipated use and neighborhood impacts
<b>COMMERCIAL USES</b>	
Adult bookstore	2.5 spaces per 1,000 sq. ft. of gross floor area
Adult entertainment establishment	5 spaces per 1,000 sq. ft. of gross floor area
Agriculture	No requirement
Automobile and light vehicle repair and service	2 spaces per 1,000 sq. ft. of gross floor area
Automobile and light vehicle sales, rental or storage	2 spaces per 1,000 sq. ft. of gross floor area
Bank	3.5 spaces per 1,000 sq. ft. of gross floor area
Bed and breakfast	1 space for manager plus 1 space per habitable unit
Building material sales	1 space per 1,000 sq. ft. of gross floor area
Business park support activities	2 spaces per 1,000 sq. ft. of gross floor area

<b>Table 50-24-1: Off-Street parking Spaces Required</b>	
<b>Use</b>	<b>Requirement* (May Be Adjusted to 30% Less or 50% More)</b>
Convention and event center	1 space per 4 seats or per 100 sq. ft. in main auditorium, whichever is greater
Daycare facility	1 space per 5 persons care capacity
Data center	1 space per 1,000 sq. ft. of gross floor area
Filling station	4 spaces per 1,000 sq. ft. gross floor area plus 1 per service stall
Funeral home or crematorium	1 space per 50 square feet of floor space in slumber rooms, parlors or individual funeral service rooms
Garden material sales	1 space per 1,000 sq. ft. of gross floor area
Grocery store	3 spaces per 1,000 sq. ft. of gross floor area
Golf course	2.5 spaces per 1,000 square feet of clubhouse area
Hotel or motel	2 spaces per 3 guest rooms plus 1 per 200 sq. ft. of gross floor area in all accessory uses including restaurants and meeting rooms
Indoor entertainment facility	2.5 spaces per 1,000 sq. ft. of gross floor area.
Kennel	1 space per 1,000 sq. ft. of gross floor area
Marina or yacht club	2.5 spaces per 1,000 sq. ft. of clubhouse area, plus 1 per 10 boat slips
Mini-storage facility	1 space per 20 storage units
Office	2.5 spaces per 1,000 sq. ft. of gross floor area
Parking lot or parking structure (primary use)	No requirement
Personal service or repair	2.5 spaces per 1,000 sq. ft. of gross floor area
Preschool	1 space per 5 persons care capacity
Restaurant	6.5 spaces per 1,000 sq. ft. of gross floor area
Retail store	3 spaces per 1,000 sq. ft. of gross floor area
Riding stable	No requirement
Seasonal camp or cabin	1 space for every two beds, or for each cabin or sleeping unit, whichever is greater
Theater	1 space per 6 seats or per 100 sq. ft. in main auditorium, whichever is greater
Tourist or trailer camp	2 spaces per 3 sleeping rooms, suites, or trailer spaces
Truck or heavy vehicle sales, rental, repair or storage	1 space per 1,000 sq. ft. of gross floor area
Vacation dwelling unit	1 space for 1-2 bedrooms, 2 spaces for 3-4 bedrooms, 3 spaces for 5+ bedrooms
Veterinarian or animal hospital	2.5 spaces per 1,000 sq. ft. of gross floor area
Other commercial use not listed	As determined by land use supervisor based on anticipated use and neighborhood impacts
<b>INDUSTRIAL USES</b>	
Airport and related facilities	As determined by airport management
<ul style="list-style-type: none"> <li>• Electric power or heat generation plant</li> <li>• Electric power transmission line</li> <li>• Junk and salvage services</li> <li>• Major utility or wireless communication tower</li> <li>• Radio or television broadcasting tower</li> <li>• Railroad or shipyard and related facilities</li> <li>• Solar or geothermal power facility (primary use)</li> <li>• Truck freight or transfer terminal</li> <li>• Water or sewer works</li> <li>• Wind power facility (primary use)</li> <li>• Bulk storage not listed</li> </ul>	No requirement
<ul style="list-style-type: none"> <li>• Contractor's shop and storage yard</li> <li>• Dry cleaning or laundry plant</li> <li>• Recycling collection point (primary use)</li> <li>• Solid waste disposal or processing facility</li> </ul>	1 per 1,000 sq. ft. of gross floor area
<ul style="list-style-type: none"> <li>• Manufacturing, light manufacturing, heavy manufacturing, hazardous or special</li> <li>• Storage warehouse</li> <li>• Water-dependent manufacturing, light or heavy</li> <li>• Wholesaling</li> </ul>	1 per 1,000 sq. ft. of gross floor area
Research laboratory	As determined by land use supervisor based on anticipated use and

**Table 50-24-1: Off-Street parking Spaces Required**

Use	Requirement* (May Be Adjusted to 30% Less or 50% More)
Other industrial uses not listed	neighborhood impacts As determined by land use supervisor based on anticipated use and neighborhood impacts
<b>ACCESSORY USES</b>	
Accessory bed and breakfast	1 space for primary use dwelling; plus 1 space per habitable unit
Accessory caretaker quarters	1 space
All other accessory uses	No requirement
<b>TEMPORARY USES</b>	
Temporary real estate sales office	2 spaces
All other temporary uses	No requirement

\*The parking space requirement may be modified by Section 50-18.5 (Higher Education Overlay District), Section 50-24.3 (Adjustment to required off-street parking) and Section 50-24.4 (Maximum parking spaces), and Section 50-37.1.L (Administrative Adjustments).

(Ord. No. 10044, 8-16-2010, § 6; Ord. No. 10096, 7-18-2011, § 27; Ord. No. 10286, 3-10-2014, § 10; Ord. No. 10340, 11-24-2014, § 1; Ord. No. 10458, 7-11-2016, § 2; Ord 10746, 5-10-2021, § 5)

**50-24.3 Adjustment to required off-street parking.**

The minimum parking requirements listed in Section 50-24.2 above shall be adjusted as follows:

**A. Proximity to transit.**

1. The minimum number of off-street parking spaces required for any development or redevelopment lands may be reduced by 30 percent if they are located within 1/4 mile of existing Duluth Transit Authority routes in operation for one year, or they may be reduced by 20 percent if located within 1/2 mile of any Duluth Transit Authority transit center, as indicated by a "T" on Exhibit 50-24.3-1;
2. If an existing transit route or center is eliminated or changed in location, any development approved in conformance with this Section 50-24.3 shall not be deemed nonconforming in terms of required parking.

50-24 Parking and Loading

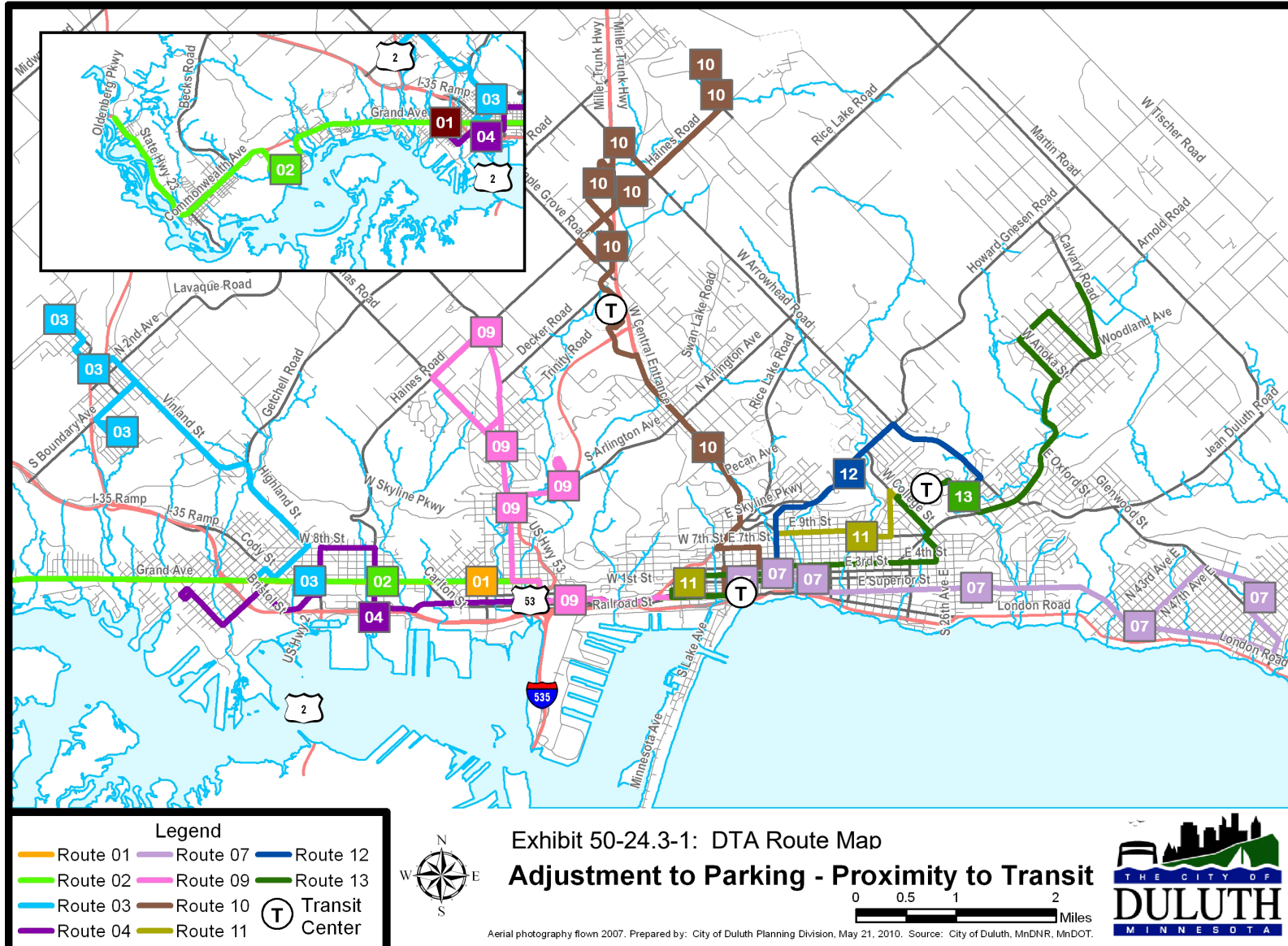

**B Sharing of parking spaces.**

1. General.

Where two land uses listed in separate use categories in Table 50-19.8 share a parking lot or structure, the total off-site parking required for those uses may be reduced by the factors shown in Table 50-24-2. Total off-street parking required shall be the sum of the two parking requirements for the two uses divided by the factors in Table 50-24-2. If uses in three or more categories of Table 50-19.8 share a parking lot or structure, the land use supervisor shall determine the parking reduction based on the relative sizes of the various uses and the reduction factors listed in Table 50-24-2;

Table 50-24-2: Shared Parking Reduction Factors					
Add the two parking requirements and divide by these factors					
Property Use	Multi-family Residential	Public, Institutional, or Civic	Food, Beverage, Indoor, Entertainment, or Lodging	Retail	Other Commercial
Public, institutional or civic	1.1	1.0			
Food, beverage, indoor, entertainment or lodging	1.1	1.2	1.0		
Retail	1.2	1.3	1.3	1.0	
Other commercial	1.3	1.5	1.7	1.2	1.0

2. Additional sharing permitted for certain uses.

As an alternative to those reduction factors listed in Table 50-24-2, (a) up to 50 percent of the parking spaces required for food, beverage and indoor entertainment uses, and up to 100 percent of parking spaces required for religious assembly uses and elementary, middle, high school, university or college auditoriums may be used jointly by (b) any non-residential use not normally open, used or operated during the same hours as those listed in (a), or any non-residential use that has excess parking capacity based on the minimum off-street parking for that use. A written agreement assuring the continued availability of the parking spaces for the uses they serve shall be required on a form approved by the city and shall be filed with the application for a building permit. (Ord. No. 10042, 8-16-2010, § 3; Ord. No. 10044, 8-16-2010, § 6; Ord. No. 10096, 7-18-2011, § 28.)

**50-24.4 Maximum parking limits.**

No more than 150 percent of the minimum required number off-street parking spaces, excluding the adjustments allowed in 50-24.3, shall be provided. This limit does not apply to the following uses: one-family, two-family, townhouse and live-work dwellings. Off-street parking spaces that existed on November 18, 2010, and that were composed of hard-surfaced, dust-free material such as concrete, bituminous, or pervious paving materials may continue even if they exceed the maximum parking limit. (Ord. No. 10042, 8-16-2010, § 4; Ord. No. 10044, 8-16-2010, § 6; Ord. No. 10096, 7-18-2011, § 29; Ord. No. 10153, 5-14-2012, § 4.)

**50-24.5 Calculation of parking spaces.**

The following rules shall apply to calculation of the number of required parking spaces:

- A. Floor area shall mean the gross floor area of the specific use;
- B. Requirements for a fraction of a parking space shall be ignored;
- C. The parking space requirement for a use not specifically listed in Table 50-24-1 shall be the same as for the most similar use listed in that table, as determined by the land use supervisor;

D. Whenever a building or use is enlarged to the extent of 25 percent or more in floor area or in the site area used, the building or use shall be required to (a) retain any on-site parking existing prior to the expansion, and if that is not sufficient to comply with the parking required for the use as expanded, then (b) to comply with the requirements in Table 50-24-1 for the expansion area;

E. Required off-street parking for one-, two-family, townhouse, multi-family, and live-work dwellings may be located in a garage or carport. (Ord. No. 10044, 8-16-2010, § 6; Ord. No. 10509, 6-12-2017, §1)

#### **50-24.6 Location of parking spaces.**

##### **A. On site location and exceptions.**

1. All required parking spaces shall be located on the same lot with the principal building or the primary use served; except as provided in subsection 2 below;
2. If an increase in the number of parking spaces is required by a change or enlargement of any use the increased parking requirement may be satisfied by utilizing:
  - (a) Primary use parking lots or parking structures located and maintained up to 500 feet from the lot containing the change or enlargement, or
  - (b) Accessory parking lots that existed on November 18, 2010, were composed of hard-surfaced, dust-free material such as concrete, bituminous, or pervious paving materials, and that are located and maintained up to 500 feet from the lot containing the change or enlargement;
3. Where required parking spaces are not provided on site, a written agreement assuring the continued availability of the parking spaces for the uses they serve shall be required on a form approved by the city and shall be filed with the application for a building permit;
4. Parking located in a public street right of way pursuant to a concurrent use permit or other public grant shall not be used to satisfy off-street parking required by Chapter 50.

##### **B. Parking location within the site.**

Parking spaces for all motorized vehicles and trailers shall only be provided on those portions of the lot indicated in Table 50-24-3. (Ord. No. 10509, 6-12-17, §2)

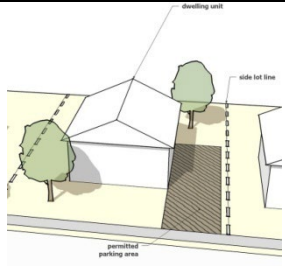
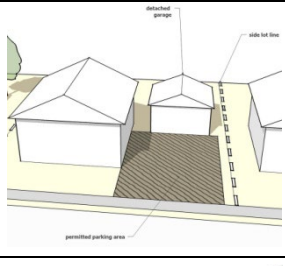
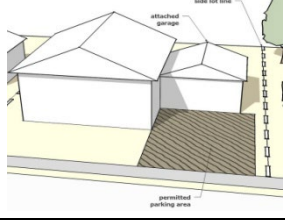
Table 50-24-3: Permitted Parking Areas	
Type of Lot	Permitted Parking Area
<b>Residential Districts</b>	
Non-corner lot with non-residential use	The rear yard and one side yard
Non-corner lot with residential use and no garage	The rear yard, and the area between one side lot line and the nearest side wall of the dwelling unit and its extension to the improved street abutting the front yard (see diagram to the right). 
Non-corner lot with residential use and detached garage	The rear yard, and the area between the closest side lot line to the side wall of the dwelling unit nearest to the garage, and its extension to the improved street abutting the front yard (see diagram to the right). 
Non-corner lot with residential use and attached garage	The rear yard, and the area between the closest side lot line to the common wall separating the dwelling unit and garage, and its extension to the improved street abutting the front yard (see diagram to the right). 
Corner lot with residential use or non-residential use	The rear yard and one side yard
<b>Mixed Use and Special Purpose Districts</b>	
All mixed use and special purpose districts	Buildings or projects constructed after November 19, 2010, shall locate no more than 50 percent of off-street accessory parking within the front yard, except as provided in Section 50-24.6.C or unless modified as part of an approved MU-I District Plan.
Form districts	Parking only permitted on those portions of the lot permitted for the building type being constructed pursuant to secs. 50-16 and 50-22.

**C. Optional pedestrian walkways within parking areas.**

For parking areas within mixed use and special purpose districts identified in Table 50-24.3, buildings or projects may locate up to 60 percent of off-street accessory parking within the front yard if a pedestrian walkway is provided. The pedestrian walkway shall:

- Include pedestrian-scaled lighting;
- Be raised or otherwise designed to encourage run-off and limit ponding during wet weather;
- Be visually recognizable to both pedestrians and motorists;
- Include trees and other landscaping along the length of the walkway, this landscaping can also be used to meet parking lot landscaping requirements in Section 50-25.4;
- Be at least eight feet wide; and
- Include well-marked crossings where the walkway intersects with private vehicle drives. (Ord. No. 10044, 8-16-2010, § 6; Ord. No. 10096, 7-18-2011, § 30; Ord. No. 10153, 5-14-2012, § 5; Ord. No. 10286, 3-10-2014, § 11; Ord. No. 10509, 6-12-2017, § 2; Ord. No. 10769, 9-27-2021, § 2)



**50-24.7 Parking lot design standards.****A. General standards.**

The design of off-street parking spaces, drive aisles, and driveways shall meet the standards shown in Table 50-24-4;

<b>Table 50-24-4: Parking Design Standards</b>		
<b>Parking Space Size*</b>		
<b>Size of Car</b>	<b>Minimum Size of Parking Space</b>	
Small	8.5 ft. x 15 ft.	
Standard	9 ft. x 17 ft.	
<b>Aisle Widths</b>		
<b>Angle of Parking</b>	<b>Minimum Width of Aisle</b>	
	<b>One-Way</b>	<b>Two-Way</b>
Parallel/no parking	11 ft.	21 ft.
30 degree	11 ft.	21 ft.
45 degree	13 ft.	23 ft.
60 degree	18 ft.	24 ft.
75 degree	20 ft.	24 ft.
90 degree	20 ft.	24 ft.
<b>Permitted Percentage of Small Car Spaces (Applies to lots with more than 5 spaces)</b>		
<b>Size of Parking Lot</b>	<b>Maximum Percentage of Small Cars</b>	
6 to 100 spaces	40%	
100 to 149 spaces	45%	
150 or more spaces	50%	
<b>Required Surface Treatment/Paving</b>		
<b>Zone District</b>	<b>Requirement</b>	
All residential district parking areas	Surfaced in a dust free, hard surface material such as concrete or bituminous, or pervious paving materials, except for rear yards which may be surfaced in aggregate materials, compressed aggregates or similar surfaces.	
All mixed use and special purpose districts	All parking areas and vehicle display lots, including on- and off-road vehicles, trailers, and all terrain vehicles, shall be surfaced in a dust free, hard surface material such as concrete or bituminous. Pervious paving material shall be approved by the city engineer.	

\*The area set aside for a parking space may encroach beyond the face of a curb a maximum of 1.5 ft., provided that (a) it does not include trees, posts, or other obstructions that would prevent a vehicle from fully utilizing the space, and (b) it is not included in required open space, landscape area requirements, or required pedestrian walkways.

**B. Parking lot and driveway entrances.**

All parking lot and driveway entrances must conform to the design specification regulations of the city engineer;

**C. Snow storage areas.**

A portion of each surface parking area shall be designated for snow storage. The areas required to meet the minimum parking requirements of this Section 50-24 shall not be used for snow storage. Snow storage areas may be landscaped if the vegetation is selected and installed so as not to be harmed by snow storage. Snow storage areas shall not count towards those landscape areas required by Section 50-25 unless they are integrated with a side or rear buffer required by Section 50-25;

**D. Parking lot walkways.**

Each surface parking area that (a) serves a multi-family residential, commercial, public, institutional, civic, or mixed use, and (b) contains 50 or more parking spaces, and (c) contains any parking spaces located more than 300 feet from the front façade of the building shall contain at least one pedestrian walkway

from allowing pedestrians to pass from the row of parking furthest from the primary building façade to the primary building entrance or a sidewalk allowing the pedestrian to reach the primary building entrance without crossing additional driving spaces or aisles. The required walkway must be at least five feet wide, shall not be located within a driving aisle, and shall be located in a landscaped island running perpendicular to the primary building façade if possible. If located in a landscaped island, the minimum width of the island shall be increased by five feet to accommodate the walkway without reducing the amount of landscaped area. If any parking space in the parking aisle located furthest from the primary structure is more than 200 feet from the walkway, additional similar walkways shall be required within 200 feet of those spaces. If there is a public sidewalk along the street frontage located within 50 feet of any required walkway, the walkway shall connect to that sidewalk;

**E. Tandem or in-line parking.**

Tandem or in-line parking, or other similar arrangements that involve the placement of two or more parking spaces in a row directly behind one another so that one parking space is blocking access for other parking spaces, is not allowed for off street parking spaces required by Chapter 50, but is allowed to meet off-street parking required in Chapter 29A. This provision does not apply to required off street parking spaces within enclosed structures, such as garages or parking structures. (Ord. No. 10044, 8-16-2010, § 6; Ord. No. 10286, 3-10-2014, § 12; Ord. No. 10340, 11-24-2014, § 2; Ord. No. 10509, 6-12-2017, §3)

**50-24.8 Required loading space.**

Unless otherwise provided in this Chapter, all construction of new buildings or expansions of existing buildings shall provide off street loading space shown in Table 50-24-5 below.

Table 50-24-5: Off-Street Loading Space Standards	
Type of Use or Facility	Off-Street Loading Requirement
Office, hotel or motel	1 space for 20,000 sq.ft. of gross floor area
Personal service and repair not otherwise listed; building material sales; garden material sales; retail store not listed (large); automobile and light vehicle repair and service, automobile and light vehicle sales, rental, or storage; truck or heavy vehicle sales, rental, repair, or storage; wholesaling.	1 space for 20,000-50,000 sq.ft. of gross floor area; and 2 spaces for more than 50,000 sq.ft. gross floor area
Manufacturing	1 space for 25,000 to 50,000 sq.ft. of gross floor area; 2 spaces for more than 50,000 sq.ft. of gross floor area.

(Ord. No. 10044, 8-16-2010, § 6.)

## **50-25 LANDSCAPING AND TREE PRESERVATION.**

---

### **50-25.1 Applicability.**

---

- A. The landscaping provisions of secs. 50-25.2 through 25.4 and 25.7 shall apply to lots and parcels in any zone district that contain (i) more than 10,000 square feet of lot area, and (ii) an existing or proposed primary structure with a multi-family, mixed use, commercial, institutional, industrial, or parking principal use, when any of the following conditions occur:
1. A new primary structure is constructed;
  2. The floor area in an existing primary structure(s), taken collectively, is increased by more than 25 percent;
  3. An existing primary structure is relocated on the lot or parcel;
  4. The primary structure is renovated or redeveloped (including but not limited to reconstruction after fire, flood or other damage), and the value of that renovation or redevelopment, as indicated by building permits, is 75 percent or more of the pre-application assessor's market value of the primary structure, as shown in the records of the city assessor;
  5. A new parking lot containing 25 or more spaces is constructed or an existing parking lot containing 25 or more spaces is reconstructed. Parking lots with less than 25 spaces must only provide the minimum tree canopy coverage as indicated in Section 50-25.4.B.6;
- B. In any form district, landscaping shall not be required on the portion of a lot occupied by a principle structure;
- C. The tree preservation provisions of Section 50-25.9 apply to all development or redevelopment on lots and parcels in any zone district that contain (i) more than 10,000 square feet of lot area, and (ii) a primary structure with a multi-family, mixed use, commercial, institutional, industrial, or parking principal use, as well as to any new lot of record created after November 19, 2010, regardless of the primary use of the property, in any zone district;
- D. The landscaping between differing land uses provisions of Section 50-25.5 apply to all development or redevelopment on lots and parcels when there is a change of use. (Ord. No. 10044, 8-16-2010, § 6; Ord. No. 10096, 7-18-2011, § 31; Ord. No. 10153, 5-14-2012, § 6; Ord. No. 10160, 6-25-2012, § 1; Ord. No. 10286, 3-10-2014, § 13, Ord. No. 10813, 09-12-22 §2)

### **50-25.2 General landscaping standards.**

---

#### **A. Landscape plan required.**

A landscape plan shall be submitted as a part of all development applications for those activities listed in Section 50-25.1.A, unless the land use supervisor determines that compliance with the provisions of Section 50-25 can be demonstrated without the use of a landscape plan. A landscape plan may be combined with other required application materials if compliance with Section 50-25 can be demonstrated in the combined materials;

#### **B. Plant materials.**

Plant materials shall be from the city's approved landscaping plant list as shown in the UDC application manual. All plant material shall be hardy to Northeast Minnesota, suitable for the site, free of disease and insects and conform to the American Standard for Nursery Stock of the American Nursery and Landscape Association;

#### **C. Minimum living materials.**

In all areas where landscaping is required, a minimum of 50 percent of the surface area shall be covered by living materials, rather than bark, gravel or other non-living materials;

**D. Existing vegetation.**

Existing vegetation shall be protected during construction through use of a fence around an area sufficient to protect the health of the vegetation, and shall be incorporated into the landscape plan wherever possible;

**E. Vegetation grouping.**

Landscaping shall generally incorporate large irregular groupings of the same species of shrub, avoiding rigid or repeated specimen planting except for boulevard trees, and shall introduce multiple varieties within one general area. Except for plantings used for screening, no one species of tree or shrub may make up more than 50 percent of the total amount of landscape plantings;

**F. Soil condition.**

All required landscaping shall be planted in uncompacted soil with a minimum depth of two feet;

**G. Grading and drainage.**

All open areas shall be graded, properly drained and maintained according to stormwater standards in Section 50-18.1.E;

**H. Raingardens and stormwater management features.**

Areas included in raingardens or vegetated site features created to meet stormwater management requirements in Section 50-18.1.E shall be counted towards any required interior site or parking lot landscaping, and if vegetated to meet the requirements for any landscaped buffers shall count towards those buffer requirements;

**I. Minimum plant sizes.**

Where included as part of the required landscaping, deciduous trees shall have a minimum caliper of 2.5 inches, coniferous trees shall be a minimum of six feet in height, large shrubs shall be of a minimum five gallon container size and have a height of at least six feet at maturity, small shrubs shall be of a minimum five gallon container size and have a height of less than six feet at maturity, and ground cover shall be of a minimum one gallon container size. The above dimensions apply to sizes at time of planting. Deciduous trees planted using air pot containers instead of balled and burlap stock may have a minimum of 2.0 inches;

**J. Plant material spacing.**

Except for buffer zone provisions of Section 50-25.5, *Landscaping between differing land uses*, plant materials shall not be placed closer than four feet from any fence line or property line. Where tree planting requirements are based on linear street frontage, areas occupied by driveways shall be included when calculating the number of trees required to be planted, and any trees that would otherwise be required in driveways shall be planted in other landscaped front yard areas unless prohibited by minimum spacing requirements for that species as recommended by the American Standard for Nursery Stock of the American Nursery and Landscape Association. The land use supervisor may authorize adjustments to these spacing requirements when required due to topography, drainage, utilities or obstructions, provided that the total amount of required landscaping is not reduced;

**K. Snow storage areas.**

Areas required for snow storage and areas required for landscaping shall not overlap, except that snow may be stored on ground cover landscape areas (e.g., turf) that do not contain required landscape trees or other plantings;

**L. City right-of-way.**

Tree removal or planting in city rights-of-way shall be done only with the approval of the city forester;

**M. Protection of site distances;**

On any corner lot on which a front and side yard are required, no wall, fence, structure, sign, or any plant growth that obstructs sight lines at elevations between 2.5 feet and six feet above the driving surface of the adjacent roadway shall be maintained in a triangle formed by measuring from the point of intersection of the front and exterior side lot lines a distance of 20 feet along the front and side lot lines and connecting the points so established to form a right triangle on the area of the lot adjacent to the street intersection;

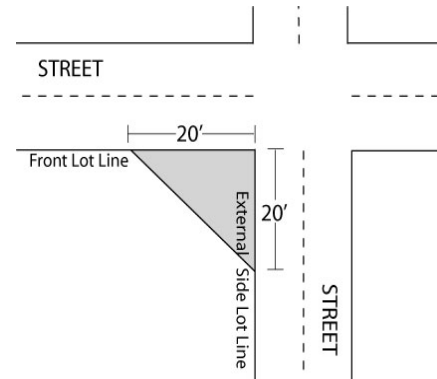
**N. Delay of installation due to season.**

Whenever the installation of required landscaping is not possible by the time construction on the primary structure or primary use parking lot has been completed, the city may authorize a delay in installation until no later than the following August 31. As a condition of authorizing a delay in installation, the city may require that a surety or other guarantee, in a form acceptable to the city, in the estimated amount of such installation be provided, or the city may issue a temporary certificate of occupancy, with the permanent certificate of occupancy to be issued following installation of all required landscaping;

**O. Flexibility for redevelopment.**

Where the requirements of this Section 50-25 apply to a redevelopment or reconstruction project, rather than a new development, the land use supervisor may authorize a reduction of minimum off-street parking requirements established in Section 50-24 by up to ten percent if required to accommodate street frontage landscaping required by Section 50-25.3 or parking area landscaping required by Section 50-25.4. (Ord. No. 10044, 8 16 2010, § 6; Ord. No. 10096, 7 18 2011, § 32; Ord. No. 10153, 5 14 2012, § 7.)

**P. Protection of required landscaping.**

Maintenance of landscaping required by this chapter, or landscape areas shown on site plans submitted as part of a zoning permit or building permit approval, is the ongoing responsibility of the property owner and his or her successors. Trees and vegetation that have died must be replaced.

Trees required by this section that are placed within 5 feet of a driving or parking surface shall be placed behind a raised curb, or planter, or similar physical barrier or obstacle to protect the tree trunks from interference by vehicles or snow removal operations. Curb openings for sidewalks or for drainage to the landscape areas are allowed.

Tree soil shall have a minimum depth of 2 feet and shall not contain different soil layers. The soil may not have any herbicides, heavy metals, biological toxins, or hydrocarbons that will impact plant growth or are at levels exceeding the EPA's standards for soil contaminants. No stones or particles greater than 1 inch in the longest dimension are permitted. This includes fragments of brick, concrete, wood, glass, metal, stone and plastic. (Ord. No. 10459, 7-11-2016, §1; Ord. No. 10670, 12-9-2019, §1)

**50-25.3 Street frontage landscaping.**

The street frontage of the property shall meet the following landscaping requirements.

A. Minimum average depth: See Table 50-25-1. An average depth allows the width of the landscape area to vary in size along different portions of the property to respond to varying site conditions and allow design flexibility;

<b>Table 50-25-1: Average Depths of Street Frontage Landscaping Required</b>	
Context	Average Depth Required
Lots with no required front setback, and where the primary building abuts the front lot line	Exempt
Lots with less than 10,000 sq. ft. or lot area	Exempt
Lots with 10,000 to 20,000 sq. ft. of lot area	5 ft. along all street frontages
Lot over 20,000 sq. ft. of lot area	15 ft. in front street yards 10 ft. in side street yards 5 ft. on rear lot lines of double frontage lots

B. Required trees: One tree per 35 feet of linear frontage, planted (a) in alignment with any similar street frontage landscaping on adjacent lots, or if that is not possible or adjacent lots do not contain front yard landscaping then (b) as close to the public right-of-way as the city engineer will permit;

C. Required shrubs: one large shrub per 25 feet of linear frontage;

D. On lots adjacent to city-maintained boulevards, landscaping in the boulevards may be credited towards the landscaping requirements of this Section 50-25.3. (Ord. No. 10044, 8-16-2010, § 6; Ord. No. 10096, 7-18-2011, § 33.)



**Figure 50-25.4-A: Parking lot screening from public right-of-way**

**50-25.4 Parking lot landscaping.**

Accessory and primary use parking lots shall provide the following amounts and types of landscaping unless alternative standards for specific situations are required pursuant to Section 50-26, *Screening, walls and fences*, or Section 50-30, *Design standards*. In any case where landscaping required by this Section 50-25.4 overlaps areas required to be landscaped by any other provision of this Section 50-25, the provisions of the section requiring more planting shall apply.

**A. Perimeter screening from public streets.**

1. Minimum width: five feet;
2. Required trees: one tree per 35 feet of linear frontage;
3. Required shrubs: three large shrubs per 25 feet of linear frontage, or if a berm or an opaque fence or wall at least three feet tall is erected, three small shrubs per 25 feet of linear frontage;

## B. Interior landscaping requirements.

Except as provided in this Section, parking lots shall provide the following landscaping internal to the parking lot:

1. Minimum area: 15 percent of the interior parking lot area (excluding any perimeter areas required to be landscaped by sections 50-25.3, 50-25.4.A or B, or 50-25.5) for parking lots with more than 50 spaces, or ten percent of the interior parking lot area for parking lots between 25 and 50 spaces;
2. Location: Internal landscape areas shall be dispersed on the site to break up the perception of large uninterrupted expanse of pavement (see Figure 50-25.4-B);
3. Required trees: One tree per 300 square feet of internal landscape area. Tree species shall be chosen so that, combined with trees planted under subsections A. and B. above, parking lots will have a minimum tree canopy coverage of 30 percent at maturity;
4. Landscape areas shall be a minimum of eight feet in width (See Figure 50-25.4-C);
5. Curbing: Internal landscape areas shall be curbed for protection of the landscape materials, but planted areas shall be installed at a lower grade than the parking lot pavement, and curbing shall allow drainage from the pavement to enter and percolate through the landscaped areas;
6. Parking areas with less than 25 spaces are exempt from the provisions of 1 through 5 of this subsection, but must provide a minimum tree canopy of 30 percent at maturity. (Ord. No. 10044, 8-16-2010, § 6; Ord. No. 10096, 7-18-2011, § 34.)

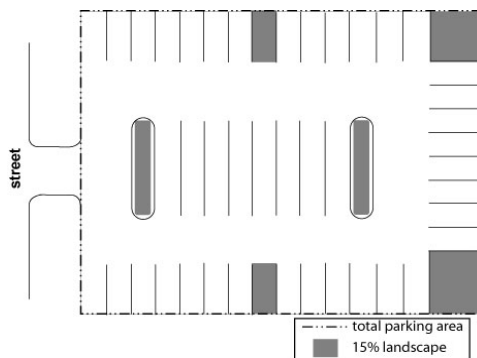

**Figure 50-25.4-B: Required interior parking lot landscape areas**

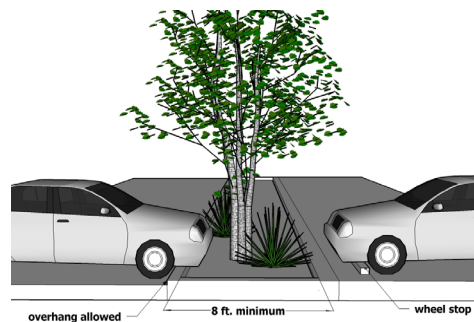

**Figure 50-25.4-C: Minimum width of interior parking lot landscape areas**

## 50-25.5 Landscaping between differing land uses.

In addition to landscaping required by sections 50-25.3 and 50-25.4, buffer areas are required to be landscaped when specific types of differing land uses occur adjacent to each other. These standards do not apply when the listed types of adjacencies occur within mixed use or form districts, but do apply where the boundaries of a mixed use or form district are adjacent to a residential or special purpose zone district. In any case where landscaping required by this Section 50-25.5 overlaps areas required to be landscaped by any other provision of this Section 50-25, the provisions of the section requiring more planting shall apply. These requirements only apply at the time of development or redevelopment (i.e., later development of an abutting land use will not result in an existing development being required to install buffer landscaping).

**A. Multi-family residential abutting single-family residential.**

Where a multi-family residential building or project with more than eight units abuts (a) a lot in the RC, RR-1, RR-2 or R-1 zone district, or (b) a lot in the R-2 district that is developed with a one-family use, a landscape buffer shall be provided using either Option A or B below.

1. Option A.

A landscape buffer area at least ten feet wide shall be provided by the multi-family project on the shared border. The buffer area shall consist of natural landscape materials such as lawn, ground cover, shrubs and trees, and shall not contain impervious materials. One tree shall be provided for every 35 feet of boundary lot line and three large shrubs per 25 feet of boundary lot line, with spacing designed to minimize sound, light, and noise impacts on single-family residential homes;

2. Option B.

An opaque wall, berm, fence or dense (at least 50 percent opacity) vegetative screen at least six feet tall shall be provided. If a fence or wall is provided, the side facing away from the multi-family use shall be at least as finished in appearance as the side facing the multi-family use, and three small shrubs per 25 feet of boundary lot line shall be provided. If a vegetative screen is proposed, it shall be at least six feet in height at the time of planting;

**B. Commercial or institutional abutting residential.**

Where a commercial, public, institutional or civic building or project abuts lots in a residential district, a landscape buffer shall be provided using either Option A or B below.

1. Option A.

A landscape buffer at least 15 feet wide shall be provided by the commercial or institutional project on the shared border. The buffer area shall consist of natural landscape materials such as lawn, ground cover, shrubs, and trees, and shall not contain impervious materials. One tree shall be provided for every 35 feet of boundary lot line and large three shrubs per 25 feet of shared lot line, with spacing designed to minimize sound, light, and noise impacts on the residential use;

2. Option B.

An opaque wall, berm, fence or dense (at least 75 percent opacity) vegetative screen at least six feet shall be provided. If a fence or wall is provided, the side facing away from the commercial or institutional use shall be at least as finished in appearance as the side facing the commercial or institutional use, and three small shrubs per 25 feet of boundary lot line shall be provided. If a vegetative screen is proposed, it shall be at least six feet in height at the time of planting;

**C. Industrial abutting residential.**

Where an industrial building or project abuts lots in a residential district or lots used for any use listed as a residential use in Table 50-19.8, a landscape buffer shall be provided using either Option A or B below.

1. Option A.

A landscape buffer at least 15 feet wide shall be provided by the industrial project on the shared border. The buffer area shall consist of natural landscape materials such as lawn, ground cover, shrubs and trees, and shall not contain impervious materials. One tree shall be provided for every 25 feet of boundary lot line and four large shrubs per 25 feet of boundary lot line, with spacing designed to minimize sound, light and noise impacts on residential uses;

2. Option B.

An opaque wall, berm, fence or dense (100 percent opacity) vegetative screen at least eight feet tall shall be provided. If a fence or wall is provided, the side facing away from the industrial use shall be at least as finished in appearance as the side facing the industrial use, and three small shrubs per 25 feet of boundary lot line shall be provided. If a vegetative screen is proposed, it shall be at least eight feet tall at the time of planting;



**D. Industrial abutting commercial or institutional.**

Where an industrial building or project abuts lots that are used or zoned for commercial, institutional or mixed use purposes, a landscape buffer shall be provided by using either Option A or B below.

1. Option A.  
A landscape buffer at least ten feet wide shall be provided by the industrial project on the shared border. The buffer area shall consist of natural landscape materials such as lawn, ground cover, shrubs and trees, and shall not contain impervious materials. One tree shall be provided for every 40 feet of boundary lot line and large four shrubs per 20 feet of boundary lot line, with spacing designed to minimize sound, light and noise impacts on commercial or institutional uses;
2. Option B.  
An opaque wall, berm, fence or dense (50 percent opacity) vegetative screen shall be provided with a minimum height of six feet. If a fence or wall is provided, the side facing away from the industrial use shall be at least as finished in appearance as the side facing the industrial use, and three small shrubs per 25 feet of boundary lot line shall be provided. If a vegetative screen is proposed, it shall be at least six feet tall at the time of planting. (Ord. No. 10044, 8-16-2010, § 6.)

**50-25.6 Landscaping credit to preserve existing trees.**

Landowners who preserve mature, non-diseased trees as part of a development project may obtain credits toward the required landscaping. Trees intended to be preserved shall be indicated on the landscaping plan and shall be protected during construction through use of a fence around the critical root radius. To obtain credit, the preserved trees shall be of a high quality and at least five inches diameter at breast height (DBH) in size. Trees located in any portion of the site protected from development or protected in its natural state as part of a zoning permit, approval or agreement shall not be eligible for credit against required landscaping on the remainder of the site. The credit for preserved trees shall be as shown in Table 50-25-2. Any preserved trees for which credit is given, and that are lost to damage or disease within two years after the credit is awarded shall be replaced by the land owner with trees otherwise required. The total amount of tree credits cannot exceed 50 percent of the required tree landscaping requirement. The entity receiving credit shall file with the city a certificate from a forester, arborist or landscape architect that states this Section has been complied with.

<b>TABLE 50-25-2: Tree Preservation Credits</b>	
<b>DBH of Preserved Tree (in in.)</b>	<b>Numbers of Trees Credited</b>
Over 12 in.	3
8 in. to 11.9 in.	2
5 in. to 7.9 in.	1

(Ord. No. 10044, 8-16-2010, § 6.)

**50-25.7 Special landscaping provisions in Canal Park area.**

In Canal Park as shown in Exhibit 50-25.7-1:

A. All open areas of a lot not covered by buildings, sidewalks, required parking areas, drives, courtyards or accessory structures shall be landscaped with a combination of trees, shrubs, flowers and ground covers;

B. Landscape design introducing a nautical character in features such as decorative walks, statuary, bollards, fountains, wood decks and terraced areas are encouraged.



**Legend**  
 Canal Park Landscaping Regulations Apply

**Canal Park Landscaping**  
Exhibit 50-25.7-1

0 125 250 500 750 Feet  
Prepared by: City of Duluth Community Planning Division, March 30, 2018. Source: City of Duluth, MnDOT, MnDNR



(Ord. No. 10044, 8-16-2010, § 6.)

**50-25.8 Alternative landscaping.**

Where compliance with the specific requirements of Section 50-25 is not possible as a result of unique site conditions abutting or surrounding a proposed site, an owner may propose alternatives consistent with the goals of Section 50-25. The land use supervisor may approve an alternative proposal where an applicant can demonstrate that the alternative proposal achieves required landscaping to the same degree, or better than, the provisions of Section 50-25. (Ord. No. 10044, 8-16-2010, § 6; Ord. No. 10153, 5-14-2012, § 8.)

**50-25.9 Tree preservation requirements.**

**A. Purpose.**

The city recognizes that trees provide numerous benefits and services to city residents, including increased property values reduced stormwater runoff and soil erosion with associated cost savings, noise buffering, aesthetic value, reduced energy costs from shade in summer and windbreaks in winter, and removal of greenhouse gases and other pollutants from the air. The city seeks to maintain the tree cover that protects the city’s water quality and gives the city its character, while recognizing the need to remove some trees for development, safety, view preservation and other purposes;

**B. Tree replacement.**

1. Exemptions.

The following activities are not subject to the tree replacement requirement in this Section 50-25.9:

- (a) Forest management activities that maintain pre-existing tree canopy cover, such as minor thinning that eliminates no more than 25 percent of the canopy;
- (b) Forestry activities that disturb the canopy are exempt if covered by a current forest management plan approved by the city forester;
- (c) Removal of trees that are an obstruction to traffic or power lines or other utilities;
- (d) Removal of trees necessary for rescue in an emergency or for clean-up after a natural disaster;
- (e) Removal of public trees deemed hazardous by the city forester;
- (f) Removal of trees that are airport hazards;
- (g) Removal and trimming of trees along Skyline Parkway to preserve views from established or historic overlooks and viewpoints, with approval by the city forester;
- (h) Installation or replacement of city streets or utilities;

2. Replacement required.

- (a) Tree replacement shall be required pursuant to Table 50-25-3;

Table 50-25-3: Tree Replacement Required				
Tree Type	Removal Threshold	Replacement Standards		
		% DBH to be Replaced	Replacement Ratio	
			If Replacing With Special Trees	If Replacing with Trees of Interest
Special Tree 20 inch DBH or greater	Prohibited unless approved pursuant to subsection (b) below	If approval received, 60% of DBH removed to be replaced	1 inch DBH per 1.5 inch of DBH required to be replaced	1 inch DBH per 1 inch of DBH required to be replaced
Special Trees Between 8 and 20 inch DBH	10 or more	40% of DBH removed to be replaced		
Trees of Interest	20 or more	20% of DBH removed to be replaced		

- (b) Removal of special tree species 20 inches diameter at breast height (DBH) or greater is prohibited unless any of the following applies:
  - (i) The city forester determines that the tree is dead, dying, diseased or a threat to public health or safety;
  - (ii) The city engineer determines that the tree interferes with the provision of public services or is a hazard to traffic;
  - (iii) The land use supervisor determines that the location of the tree is preventing development or redevelopment that cannot be physically designed to protect the tree;

- (c) When ten or more replacement trees are required, not more than 30 percent shall be the same species without approval from the city forester;
- (d) Replacement trees provided pursuant to this Section 50-25.9 shall count towards landscaping required under other portions of this Section 50-25.9 if they meet the size, type and location standards for the type of landscaping required;
- (e) Replacement trees shall be considered significant trees in any future tree replacement plan;
- (f) If any part of the property is permanently protected from development by a conservation easement or by transfer to a city park or other natural area or a private conservation organization, the combined diameter of the protected trees that meet the size requirement for a significant tree will count toward the replacement requirement;
- (g) With the approval of the appropriate city staff (land use supervisor or city forester), developers should have the option of meeting the tree replacement requirements by putting equivalent funds into a dedicated city tree account. The amount of funds should be calculated based on the cost to the city of hiring contractors to plant the number of required replacement trees;

3. Calculation.

- (a) If you meet the removal threshold:

$$\frac{\text{Inches removed(DBH)}}{\% \text{ DBH}} \times \% = \text{replacement requirement in inches}$$

- (b) If replacing with special trees:

$$\text{Replacement requirement} \div 1.5 = \text{Total inches required}$$

- (c) If replacing with other trees:

$$\text{Replacement requirement} = \text{Total inches required};$$

4. Example.

Step 1: Removal of twelve 10-inch special trees = Total of 120 in. DBH

Step 2: 120 inch DBH x 40% = 48 inch replacement requirement

Step 3: If replacing with special tree species: 48 inch ÷ 1.5 = 32 inch total inches required to be planted;

5. Tree replacement plans.

Where this replacement requirement applies, the applicant shall submit a tree replacement plan prepared and certified by a certified forester, arborist or landscape architect. The tree replacement plan shall be part of and integrated with the landscaping plan for the site. No replacement shall occur until the city forester has approved the tree replacement plan, and all replacement shall be consistent with that approved plan. The plan shall meet all applicable requirements in the UDC application manual;

6. Calculation for developments exceeding five acres.

For development of forested acres over five acres, with the approval of the appropriate city staff, the total diameter of trees removed should be able to be estimated based on measuring the diameter of trees in representative sample plots. The plots should be scattered throughout the area to be cleared and should cover no less than ten percent of the entire area. All special tree species in the forest must be measured. (Ord. No. 10044, 8-16-2010, § 6; Ord. No. 10096, 7-18-2011, § 35, Ord. No. 10670, 12-9-19, §2)

**50-26 SCREENING, WALLS, AND FENCES.**

**50-26.1 Screening of mechanical equipment.**

**A. Applicability.**

The standards of this Section shall apply to all of the following uses that contain a primary structure in all zones, except I-G and I-W: a multi-family, mixed use, commercial, institutional, industrial, or parking principle use, when any of the following conditions occur:

- 1. A new primary structure is constructed;
- 2. The floor area in an existing primary structure(s), taken collectively, is increased by more than 25 percent;
- 3. An existing primary structure is relocated on the lot or parcel;
- 4. The primary structure is renovated or redeveloped (including but not limited to reconstruction after fire, flood or other damage), and the value of that renovation or redevelopment, as indicated by building permits, is 25 percent or more of the pre-application assessor's market value of the primary structure, as shown in the records of the city assessor.

The standards of this Section shall not apply if the only feasible location for mechanical screening would impede the functioning of solar, wind or geothermal energy equipment or systems if such systems are otherwise in compliance with applicable building codes and zoning requirements;

**B. Screening standards.**

The following exterior mechanical features shall be screened: (i) electrical and gas-powered mechanical equipment and power systems equipment; (ii) heating, ventilating and air conditioning equipment ductwork, and lines; and (iii) power systems equipment. Roof or wall-mounted antennas and vent openings shall not be considered mechanical equipment for purposes of these screening standards.

- 1. Roof-mounted mechanical equipment.  
Roof-mounted mechanical equipment shall be screened by a parapet wall or similar feature that is an integral part of the building's architectural design. The parapet wall or similar feature shall be sufficient to screen the mechanical equipment from ground view of a person on the other side of the public right-of-way on which the structure fronts, as illustrated in Figure 50-26.1-A;

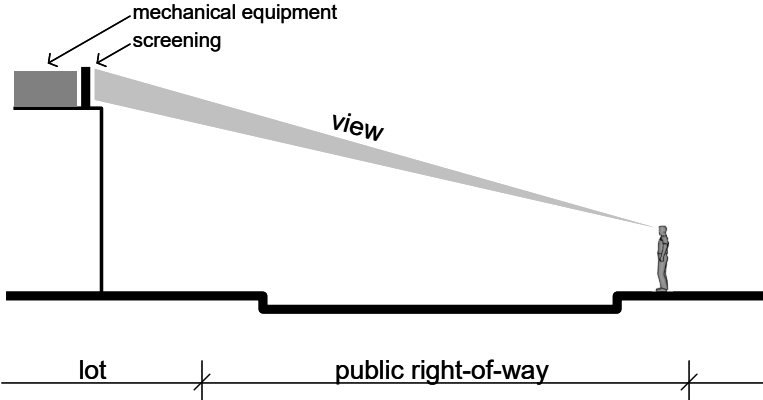

**Figure 50-26.1-A: Screening for roof-mounted mechanical equipment**

- 2. Ground-mounted mechanical equipment.  
Ground-mounted mechanical equipment shall be screened from view from ground view of adjoining properties and public right-of-way by landscaping or by a decorative wall that incorporates at least one of the primary materials and colors of the nearest wall of the primary structure. The wall shall be of a height equal to or greater than the height of the mechanical equipment being screened. If landscaping is used for screening, the screening material shall be

designed to provide 75 percent opacity one year after planting along the full required height and length of the screening buffer. (Ord. No. 10044, 8-16-2010, § 6; Ord. No. 10096, 7-18-2011, § 36; Ord. No. 10153, 5-14-2012, § 9, Ord. No. 10562, 4-9-18, § 1; Ord. No. 10562, 4-9-2018, § 1)

### **50-26.2 Screening of service and off-street loading areas.**

---

#### **A. Applicability.**

These standards shall apply to all service areas and off-street loading areas on all properties containing multi-family dwellings, commercial, institutional, industrial or mixed uses, except those located in the I-G and I-W districts.

#### **B. Screening.**

Service and off-street loading areas shall be designed and located to reduce the visual and acoustic impacts of these functions on adjacent properties and public streets. Non-enclosed service and off-street loading areas shall be screened with durable, sight-obscuring walls, fences, and/or dense indigenous evergreen planting of between six and eight feet in height. Screening materials shall be the same as, or of equal quality to, the materials used for the primary building and landscaping. (Ord. No. 10044, 8-16-2010, § 6.)

### **50-26.3 Screening and location of commercial containers.**

---

#### **A. Applicability and exemptions.**

1. Except as noted in subsection 2 below, these standards shall apply to all exterior commercial containers, including without limitation garbage dumpsters, grease/oil tanks and cardboard compactors, on all properties containing multi-family dwelling, commercial, institutional, industrial or mixed uses;
2. These standards shall not apply to the following:
  - (a) Commercial containers located in the I-G and I-W districts;
  - (b) Commercial containers located behind a building and not visible from a public street or adjoining single-family, multi-family, mixed use or public property;
  - (c) The temporary purpose of disposing of waste generated during the time of an active building permit, or 180 days, whichever is shorter, for the demolition or construction of improvements on the property upon which the commercial container is located;
  - (d) A commercial container placed by or upon written authority of the city on a temporary basis;



**Figure 50-26.2-A: Loading area screening**

**B. Location.**

Commercial containers shall not be placed in any of the following:

1. Any required front yard area or any side yard area adjacent to a public street right-of-way;
2. Any fire lane;
3. Any required off-street parking space;
4. Any location that blocks vehicular or pedestrian traffic;
5. Any location that obstructs drivers' sight lines at intersection of streets and driveways;
6. Any location that may interfere with utilities;

**C. Screening of commercial containers.**

1. Not adjacent to structure wall.

Commercial containers that are not located adjacent to a wall of an existing principal or accessory structure shall be screened from view as follows:

- (a) On three sides with a wall constructed of masonry, brick, wood, stone, or similar material and at least as tall as the container being screened;
- (b) On the fourth side a gate constructed of wood or metal and at least as tall as the container being screened;

2. Adjacent to structure wall.

Commercial containers that are located adjacent to a wall of an existing principal or accessory structure shall be screened from view as follows:

- (a) On two sides with a wall that is (1) constructed of the same principal materials and colors used on the wall of the principal or accessory building that forms the third wall of the enclosure, and (2) at least as tall as the container being screened; and (3) in compliance with applicable fire and building codes;
- (b) On the fourth side a gate constructed of wood or metal and at least as tall as the container being screened. (Ord. No. 10044, 8-16-2010, § 6.)



**Figure 50-26.3-A: Dumpster screening**

### 50-26.4 Fences and walls.

Unless otherwise expressly provided for in this Chapter, or unless expressly provided for in conjunction with the approval of a special use permit, fences and walls shall comply with the following general standards:

#### A. Fence/wall standards

1. General front yard standards.

- (a) No fence or wall located between the principal structure on a lot and the front property line shall exceed four feet in height. If a fence is constructed with an ornamental material, such as wrought iron, a six foot high fence may be allowed with an approved zoning permit provided that the fence is at least 50 percent open or transparent;
- (b) Chain link fences, fences that are electrically charged, fences constructed of barbed or razor wire and fences constructed of temporary plastic fencing (snow fences) are prohibited. A durable, vinyl-coated, chain link fence, no more than four feet tall, may be allowed with an approved zoning permit;
- (c) Prohibitions on electrically charged fences shall not apply to fences used to protect gardens and landscaping on residential lots. Prohibitions on electrically charged fences and fences constructed of barbed or razor wire shall not apply to fences used to enclose livestock on bona fide farms and those serving a public or quasi-public institution for public safety or security purposes;

2. General side and rear yard standards.

Fences that are electrically charged, and those constructed of barbed or razor wire shall be prohibited.

- a) This prohibition shall not apply to electrically charged fences used to protect gardens and landscaping on residential lots;
- b) This prohibition shall not apply to fences used to enclose livestock on bona fide farms and those serving a public or quasi-public institution for public safety or security purposes;

3. Residential zone districts.

The maximum height of a fence or wall within required side and rear yard area is eight feet. The maximum height for fences and walls for entry gates at the residential subdivision entrance shall be eight feet;

4. Mixed use and special purpose zone districts.

The maximum height of a fence or wall within required side and rear yard area is eight feet, but the land use supervisor may approve a fence or wall up to 12 feet in height where additional height is needed to provide adequate security because of topography or the nature of the material or equipment stored in the area;

5. Form districts.

The maximum height of a fence or wall within required side and rear yard area is eight feet, but the land use supervisor may approve a fence or wall up to 12 feet in height where additional height is to provide adequate security because of topography or the nature of the material or equipment stored in the area. Fences and walls are not permitted in required front yard areas, except for wrought iron fences used to enclose outdoor patio or dining areas, in which case the maximum height of the fence shall be three feet;



Figure 50-26.4-A: Form district front setback wall height



6. Vacant property.

As an exception to other fence height limits, vacant property may be fenced with chain-link fencing not to exceed six feet in height when the purpose of such fencing is to prevent unauthorized dumping or soil disturbance that results in fugitive dust or nuisance conditions. Such fencing of vacant property shall not be construed to allow use of the property for outdoor storage;

7. Permit required.

No fence shall be constructed in dedicated rights of way without a concurrent use permit. Any fence that exceeds four feet in height is required to have an approved zoning permit prior to construction;

8. Finished Side

All fences and walls shall be installed with the finished side facing out, so that posts and lateral supports are not on the side of the fence or wall which faces an adjacent property or public right-of-way, unless such supporting members are exposed on both sides due to the specific design of the fence or wall;

## B. Retaining walls standards.

1. Applicability.

The requirements of this Section apply to construction of new retaining walls in all districts, except for (a) retaining walls on proper-ties containing only one-family and two-family dwellings, and (b) retaining walls that will not be visible from neighboring sites or from a public street frontage;

2. Design standards.

All retaining walls shall comply with the following standards:

- (a) Retaining walls more than six feet tall shall be terraced to minimize visual impacts on residents, neighboring properties and the public realm;
- (b) Terracing shall be limited to three tiers;
- (c) A terrace at least four feet wide, with a maximum slope of 3:1, shall be provided between each tier to create pockets for landscaping. Reduced terrace depths may be administratively approved by the building official where site constraints limit the amount of space available to accommodate the minimum required width;
- (d) Terraces between retaining wall tiers shall be vegetated with permanent landscaping to screen retaining walls and provide visual interest unless soil conditions are determined by a licensed engineer to be unsuitable due to geologic hazards;
- (e) Retaining walls shall be stacked natural stone or faced with stone or earth-colored materials, textured and colored Mechanically Stabilized Earth (MSE) blocks or other material compatible with the primary building materials;
- (f) Retaining walls constructed of railroad ties, timber and gabion-type materials are not allowed;



**Figure 50-26.4-B: Retaining wall terracing and articulation**

## C. Materials.

No fence, wall or retaining wall shall be constructed of scrap or waste materials unless those materials have been recycled, or reprocessed into building materials for sale to the public. No sign may be posted on any fence, wall or retaining wall except for a property identification/management sign not exceeding one square foot in size. (Ord. No. 10041, 8-16-2010, § 6; Ord. No. 10044, 8-16-2010, § 6; Ord. No. 10096, 7-18-2011, § 37; Ord. No. 10153, 5-14-2012, § 10; Ord. No. 10414, 10-12-2015, § 4; Ord. No. 10562, 4-9-2018, § 1)

**50-26.5 Alternative screening.**

---

Where compliance with the specific requirements of Section 50-26 is not possible as a result of unique site conditions abutting or surrounding a proposed site, an owner may propose alternatives consistent with the goals of Section 50-26. The land use supervisor may approve an alternative proposal where an applicant can demonstrate that the alternative proposal achieves required landscaping to the same degree, or better than, the provisions of Section 50-26. (Ord. No. 10153, 5-14-2012, § 11.)

## 50-27 SIGNS.

---

### 50-27.1 Permit required.

---

- A. All signs that require a permit, as described in Section 50-27.7, must obtain a zoning permit as described in Section 50-37.13 (*Zoning permit*) of this Unified Development Chapter;
- B. When submitting a zoning permit application for a sign, the applicant must submit photographs and dimensions of all signs existing on the lot, including all signs that will be removed. The city may request that the applicant submit photographs of all new signs erected on the lot after permit issuance;
- C. The applicant must sign the zoning permit application attesting to the accuracy of the information provided. The city may revoke any sign permit where there has been a violation of the provisions of this section or misrepresentation of fact on the zoning permit application;
- D. All freestanding signs over seven feet in height must submit construction plans prepared by a design professional licensed in Minnesota that comply with the requirements of the Minnesota State Building Code. (Ord. No. 10044, 8-16-2010, § 6; Ord. No. 10047, 8-30-2010, § 1; Ord. No. 10204, 3-11-2013, § 1; cited only by Ord. No. 10222, 5-13-2013, § 1; Ord. No. 10338, 11-24-2014, § 1.)

### 50-27.2 Enforcement.

---

- A. No sign permit shall be required for the types of signs shown in Table 50-27-1, but each such sign shall be required to comply with the provisions of this Section 50-27. Any sign placed on public property or within a public right-of-way or public easement without authorization or without a required sign permit can be removed without notice. Such signs will be held by the city for 30 days. The owner of the sign may reclaim the sign within such period, subject to any fines imposed by the city. If not reclaimed, the city may destroy the sign following expiration of the 30 day period;
- B. If a sign is constructed illegally, either without a required permit or in violation of this section or previous sign regulations, the city may serve notice to the property owner that such sign must be removed or the violation corrected within 30 days. If the sign is not removed or the violation corrected within the 30 day period, the city may remove the sign at the property owner's expense. An extension of this 30 day period may be granted per Section 50-37.1.O (*Appeals*) of this Chapter, and must be applied for prior to expiration of the initial 30 day period. (Ord. No. 10044, 8-16-2010, § 6; Ord. No. 10204, 3/11/2013, § 1; cited only by Ord. No. 10222, 5-13-2013, § 1.)

### 50-27.3 Design and construction standards.

---

All signs constructed, erected, modified or altered must comply with the provisions of this Section and the requirements of the City Code.

#### A. Prohibited sign location.

1. No sign may be erected in a location that violates the Minnesota State Building Code, Minnesota State Fire Code or other regulations;
2. No sign, other than that placed by agencies of government or a sign whose placement is authorized by this Section or the city, may be erected in the public right-of-way or on public property;
3. Signs located on public right-of-ways or on/in public or private skywalks must comply with Chapter 44A of the City Charter;
4. No sign may be erected on private property without prior consent of the property owner;
5. No sign may be erected in violation of the view obstruction provisions of Section 50-25.2.M (*Protection of site distance*) with the exception of a freestanding pole sign, if permitted in the district, with a diameter no greater than one foot and where the sign face is mounted a minimum of eight feet above grade. No sign can be erected that obstructs free and clear vision of any street, intersection, parking lot ingress or egress, or driveway;
6. No sign may be erected in a manner that obstructs access to fire escapes, any ingress or egress,

or standpipes;

7. No sign may be erected on the exterior of a building to cover any windows or doors;
8. Signs on lots adjacent to state or county highways shall conform to the respective setbacks and other standards of the state and county highway departments;
9. Freestanding monument signs shall not be located closer than three feet from the lot line;
10. The supporting pole of a freestanding pole sign shall be setback from the lot line a minimum of three feet, but the sign itself may be up to the lot line. No part of a freestanding pole sign may encroach on a public right-of-way;

**B. Sign dimension measurement methodology.**

1. General measurement of sign area. Sign area is measured as follows:

- (a) For signs on a background, the entire area of the framework or background of the sign is calculated as sign area, including any material or color forming the sign face or background used to differentiate the sign from the structure against which it is placed. Sign area does not include any supports or bracing, unless such framework or bracing is part of the message or sign face;
- (b) For signs consisting of freestanding letters or logos, the sign area is calculated as the total area of each square, circle, rectangle or triangle, or combination thereof, that encompasses each individual letter or logo. Sign area does not include any supporting framework or bracing, unless such framework or bracing is part of the message or sign face;
- (c) For awning and canopy signs, the sign area is the printed area of the awning or canopy, calculated as the total area of each square, circle, rectangle or triangle, or combination thereof, that encompasses each individual letter or logo;
- (d) Window signs printed on a transparent film and affixed to the interior or exterior of a windowpane are calculated as individual letters or logos, provided that the portion of the transparent film around the perimeter of the individual letters or logos maintains 100 percent transparency of the window. Transparency is defined as both the ability to view into the interior of the establishment from the outside and to view the outside from the interior of the establishment through the same area;
- (e) The sign area of a three-dimensional,

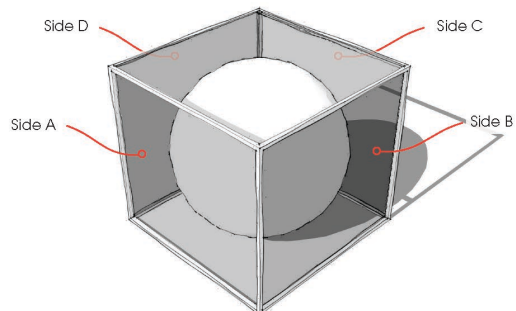
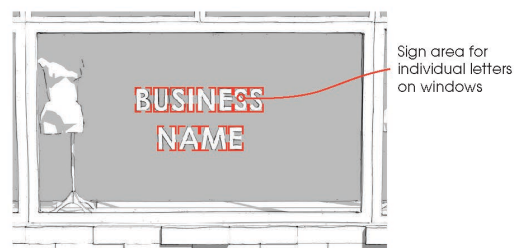

free-form or sculptural (non-planar) sign is calculated as 50 percent of the sum of the area of the four vertical sides of the smallest cube that will encompass the sign;

- (f) If a sign has two or more faces, the area of all faces is included in determining the area of the sign, unless the two sign faces are placed back-to-back and are no more than two feet apart. In such case, the sign area is calculated as the area of one face. If the two faces are unequal in area, the area of the larger face is used to calculate sign area;
  - (g) Necessary supports or uprights on which the sign is erected are not included in the sign area computation.
2. General measurement of sign height.
    - (a) Pole sign height is measured from the grade to the uppermost point of the sign. Grade is established by the elevation of the back of curb or, if no curb exists, from the edge of pavement at the center of the abutting street frontage where the sign will be erected. The pole sign height may also be measured from the natural slope of the lot where the sign will be erected;
    - (b) Monument sign height is measured from the existing lowest point of the ground where the monument sign is to be installed to the uppermost point of a sign;

### C. Construction standards.

1. Supports and braces must be designed as an integral part of the overall sign design and hidden from public view to the extent technically feasible;
2. All signs attached to a building must be installed and maintained so that wall penetrations are watertight and the structure does not exceed allowable stresses of supporting materials;
3. All signs must be designed and constructed in accordance with Minnesota State Building and Fire codes. Marquee structures must be approved by the city engineer and building safety department;
4. Glass forming any part of a sign must be safety glass;
5. All letters, figures, characters or representations in cut-out or irregular form, maintained in conjunction with, attached to or superimposed upon any sign must be safely and securely built into or attached to the sign structure;
6. Audio components are prohibited on any sign, with the exception of menuboards;
7. Any form of pyrotechnics is prohibited;

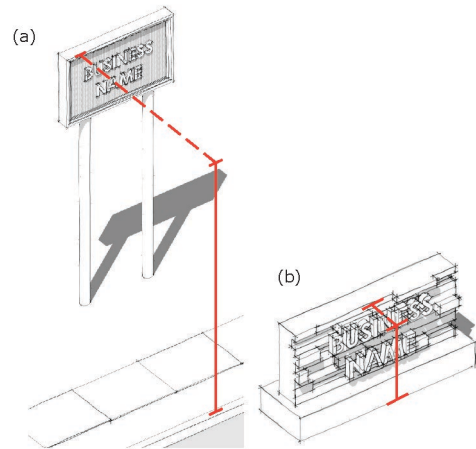

### D. Electrical wiring.

1. All electrical fixtures, devices, circuits, conduits, raceways or apparatus used to illuminate, move or project any sign must be installed and maintained in accordance with Minnesota State Building Code, including the National Electrical Code. Electrical permits are required for sign installation in accordance with the Minnesota State Building Code;
2. Conduits and other components of a sign illumination system must be designed as an integral part of the overall sign structure and hidden from public view to the extent technically feasible;

### E. Permit identification.

Every sign must include an identification of the permit number and name of sign installer either painted on the sign or by the application of a metallic sticker. The information must be visible from the ground with the exception of signs mounted seven or more feet above grade;

**F. Required landscaping.**

All freestanding signs, except in lots zoned I-G and I-W, must be landscaped at the base of the sign in accordance with the following:

1. Freestanding signs must be landscaped with small shrubs a minimum of 18 inches in height at planting, spaced appropriately based on mature height and spread to provide continuous screening of sign base once shrubs have reached maturity. The remainder of the landscape area must be planted with perennials, turf or other live groundcover;
2. Landscape must extend a minimum of two feet from the sign base on all sides. If this two foot area extends into the right-of-way, landscape is not required within the right-of-way area. All landscape must be maintained in good condition, and free and clear of rubbish and weeds. Landscape around the base of a sign is included in the total amount of landscape required on a site, if applicable;
3. There is no requirement regarding the mature height of landscape, though landscape must be tailored to the scale of the sign. Landscape may be trimmed and maintained along the sign base to maintain visibility of the sign face;
4. When a monument sign is designed as a single structure where the pediment is constructed of similar or complimentary materials as the sign, and no structural elements that are not related to such overall design of the sign are visible, no landscape is required;

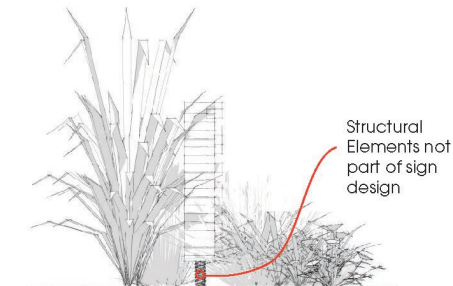

**G. Required sign maintenance.**

1. All signs must be maintained in a safe, neat and orderly condition and appearance, and must be repainted or otherwise maintained by the property owner to prevent corrosion or deterioration caused by the weather, age or any other condition;
2. All signs must be maintained to prevent any kind of safety hazard, including faulty sign structures, a fire hazard or an electrical shock hazard;
3. All unused sign hardware or wiring that is visible from the right-of-way must be removed;
4. If a sign is maintained in an unsafe or insecure condition, the city will give written notice to the property owner. If property owner fails to remove or alter the structure to comply with the standards of this Section, the sign may be removed by city at the expense of the property owner. The city may remove any sign that is an immediate peril to persons or property summarily and without notice;

**H. Noncommercial messages.**

A noncommercial message may be substituted for a commercial message on any sign permitted by this Section.

## I. Permit identification.

All architectural signs on a structure announcing the original or historic name of the building, year of construction, or insignias must be maintained, and cannot be removed, altered, or covered. Such signs are not calculated as part of any sign area or maximum number of signs permitted by this Section. (Ord. No. 10044, 8-16-2010, § 6; Ord. No. 10047, 8-30-2010, § 2; Ord. No. 10204, 3-11-2013, § 1; cited only by Ord. No. 10222, 5-13-2013, § 1.)

### **50-27.4 Illumination standards.**

The following illumination standards apply to on-premises signs. Illumination of billboards (off-premises) are regulated separately in Section 50-27.7. Additional illumination requirements for electronic message signs are found in Section 50-27.7.

- A. Any sign illumination, including gooseneck reflectors, external illumination and internal illumination, must be designed, located, shielded and directed to prevent the casting of glare or direct light upon roadways and surrounding properties, or the distraction of motor vehicle operators or pedestrians in the public right-of-way;
- B. The sign face of internally illuminated signs must function as a filter to diffuse illumination. The sign face must cover all internal illumination components so that no exposed bulbs are visible;
- C. All external illumination of a sign must concentrate the illumination upon the printed area of the sign face;
- D. No sign illumination may exceed one footcandle of illumination at the property line;
- E. The use of neon lighting as a sign material or sign accent is permitted for signs within the mixed-use, form-based and special purpose districts, with the exception of the MU-N and MU-B districts where it is prohibited. Neon lighting is subject to the following:
  1. When lit, neon lighting must be continuously illuminated. Flashing neon is prohibited;
  2. Neon lighting cannot be combined with any reflective materials (e.g., mirrors, polished metal, highly-glazed tiles, or other similar materials) that would cause glare and increase the spread of light;
  3. Neon lighting to outline doors and windows is prohibited;
- F. The use of LED lighting as a sign accent is permitted, subject to the following:
  1. LED lighting as an accent is only permitted for non-residential uses in the mixed-use, form-based and special purpose districts where electronic message center signs are permitted. LED accent lighting is prohibited in any residential district;
  2. LED lighting as an accent must comply with all illumination requirements of an electronic message center sign;
  3. The addition of LED lighting as an accent to an existing sign requires a zoning permit;
  4. When lit, LED lighting must be continuously illuminated. Flashing LED is prohibited;
  5. LED lighting cannot be combined with any reflective materials (e.g., mirrors, polished metal, highly-glazed tiles, or other similar materials) that would cause glare and increase the spread of light;
  6. LED lighting to billboards, free standing monument signs, outline doors, windows, any part of a structure and automobile and filling station gas canopies is prohibited;
  7. LED lighting to outline free standing pole signs is allowed but lighting must conform to the same brightness standards as electronic message centers as identified in UDC Section 50-27.7.G. (Ord. No. 10044, 8-16-2010, § 6; Ord. No. 10047, 8-30-2010, § 3; Ord. No. 10204, 3-11-2013, § 1; cited only by Ord. No. 10222, 5-13-2013, § 1; Ord. No. 10338, 11-24-2014, § 2.)

### **50-27.5 Prohibited signs.**

---

The following signs are prohibited:

- A. Balloon and air-infused/air-inflated signs;
- B. Electronic display screens;
- C. Flashing or animated signs;
- D. Illegally-affixed signs;
- E. Moving signs, including signs moved by wind or mechanical or electrical components. No sign or part of any sign shall move or give the illusion of movement in any manner. Clocks and barber poles are exempt from this provision;
- F. Portable signs. Portable signs include both signs mounted on a wheeled structure and those mounted on a stationary structure that can be moved and is not permanently installed on a site;
- G. Roof signs;
- H. Snipe signs;
- I. Strobe lights, moving or fixed spotlights, and floodlights;
- J. Temporary off-premises signs;
- K. Traffic hazard signs. Any sign that constitutes a traffic hazard is prohibited, including signs that:
  - 1. Interfere with, obstruct the view of, or may be confused with any authorized traffic sign, signal or device because of its position, shape or color, including signs illuminated in red, green or amber color to resemble a traffic signal;
  - 2. Make use of the words STOP, LOOK, DETOUR, DANGER, CAUTION, WARNING or any other word, phrase, symbol or character in a manner that misleads, interferes with or confuses traffic;
- L. Vehicle signs. Signs placed or painted on parked vehicles where the primary purpose is to advertise a product or service, or to direct the public to a business or activity located on or off the premises, are prohibited. Signs painted on vehicles, trucks or buses, which are being operated and stored in the normal course of business, such as signs located on delivery trucks, promotional vehicles, moving vans and rental trucks, are permitted, provided that the primary purpose of such vehicles is not the display of signs, and that they are parked or stored in areas related to their use as vehicles. Vehicle for-sale signs are exempt from this provision. (Ord. No. 10041, 8-16-2010, § 7; Ord. No. 10044, 8-16-2010, § 6; Ord. No. 10047, 8-30-2010, § 9; Ord. No. 10096, 7-18-2011, § 38; Ord. No. 10204, 3-11-2-13, § 1; cited only by Ord. No. 10222, 5-13-2013, § 1.)

### **50-27.6 Signs and activities exempt from permit requirements.**

---

#### **A. Alternation and maintenance operations.**

The following activities are exempt from a zoning permit:

- 1. Painting, repainting, cleaning, and/or other normal maintenance and repair of a sign, not involving structural alterations or changes in the electrical components of the sign. Repairs to existing permitted illumination components are also exempt from sign permit requirements;
- 2. Changing of the message of an existing changeable message sign or electronic message sign;
- 3. Changing the sign face within an existing legal sign structure, provided no alterations are made to the sign structure and the sign area, sign height or any other dimension of the sign;

#### **B. Illumination.**

No exempt sign may be illuminated, except for the following:

- 1. Uplighting of official federal, state, county or city flags;
- 2. Lighting of official federal, state, county or city government signs as needed by the government body;



### C. Exempt permanent signs.

This Section describes the types of permanent signs that are allowed without a zoning permit. All exempt signs must comply with all the regulations of this section. Exempt permanent signs are subject to the regulations of Table 50-27-1: *Exempt Permanent Sign Regulations*.

TABLE 50-27-1: EXEMPT PERMANENT SIGN REGULATIONS						
SIGN	PERMITTED DISTRICT OR USE	PERMITTED SIGN TYPE	MAXIMUM SIZE	MAXIMUM HEIGHT (FREE-STANDING SIGNS)	REQUIRED SETBACK OR LOCATION (FREESTANDING SIGNS)	NUMBER PER LOT
Agricultural Identification Sign	All agricultural uses	Freestanding or wall	RC, RR-1, RR-2: 20sf All other districts: 6 sf	6'	20' from front lot line & 10' from any other lot line	1 per street frontage
Bed and Breakfast	Bed and breakfast uses	Freestanding or wall	12 sf	7'	5' from any lot line	1 per lot
Building Directory Sign	All multi-family & non-residential uses	Freestanding or wall	6 sf	7'	Within 10' of building entry	1 per building entry
Day Care Facility	Residential zone districts	Wall or non-illuminated lawn sign	6 sf	7'	5' from any lot line	1 per lot
Flags – Federal, State or Local	All districts and uses	Freestanding	No Limit	No limit	5' from any lot line	No limit
Flags – Commercial	All non-residential uses	Freestanding	16 sf	Flagpole limited to maximum height of zoning district	5' from any lot line	1 per lot
Government Information Sign (Federal, State, County or City)	All districts & uses	Freestanding or wall	No Limit	No Limit	No Limit	No Limit
Home Occupation Sign	All residential dwelling uses and permitted accessory uses	Wall, window or freestanding including mounting on private lightposts	4 sf	4'	5' from any lot line	1 per lot
Memorial Plaque	All districts and uses	Freestanding or wall	No limit	Limited to maximum height of zoning district	5' from any lot line	1 per lot
Nameplate	All districts and uses	Wall	4 sf	(Not Applicable)	(Not Applicable)	1 per lot
Parking Lot Directional Sign	All parking lots and structures	Freestanding	4 sf	7'	0' from any lot line	No limit
Parking Lot Information Sign	All parking lots and structures	Freestanding or wall	16 sf	12'	0' from any lot line	3 per access point
Property Identification Sign	All multi-family residential uses	Wall	4 sf	(Not Applicable)	(Not Applicable)	1 per lot

TABLE 50-27-1: EXEMPT PERMANENT SIGN REGULATIONS						
SIGN	PERMITTED DISTRICT OR USE	PERMITTED SIGN TYPE	MAXIMUM SIZE	MAXIMUM HEIGHT (FREE-STANDING SIGNS)	REQUIRED SETBACK OR LOCATION (FREESTANDING SIGNS)	NUMBER PER LOT
Public Information Sign	The following uses: All educational facilities; cemetery or mausoleum; museum, library or art gallery; park, playground or forest reserve	Freestanding or wall	No limit	No limit	No limit	No limit
Public Information School and Field Identification Sign	All districts. K-12 public and private schools. Only to identify name of school, recreation field, or athletic team.	Nonilluminated wall sign	No limit	No limit	No limit	No limit
Permanent Window Sign	All non- residential uses	Window	Temporary & permanent signs (combined) are limited to 30% coverage of each window	(Not applicable)	(Not applicable)	(Not applicable)
Time and Temperature Sign (Electronic)	All non- residential uses	Must be integrated into primary freestanding or wall sign	20% of sign area of free-standing or wall sign, or if stand-alone sign, 6 sf	(Not Applicable)	(Not Applicable)	1 per lot

**D. Exempt temporary signs.**

This Section describes the types of temporary signs that are allowed without a zoning permit. All exempt signs must comply with all the regulations of this Section.

1. Exempt temporary signs are subject to the display periods in Table 50-27-2: *Permitted Display Period*.

TABLE 50-27-2: EXEMPT TEMPORARY SIGN PERMITTED DISPLAY PERIOD	
SIGN	PERMITTED DISPLAY PERIOD
Attention-Getting Device	When related to a time-specific event: Combined display period of 14 days prior to the event, the time period of the event and 2 days following the event When not related to a time-specific event: 10 days Limited to no more than 4 display periods in a year, with a minimum of 30 days between displays
Banner (General)	When related to a time-specific event: Combined display period of 14 days prior to the event, the time period of the event and 2 days following the event When not related to a time-specific event: 30 days Limited to no more than 4 display periods in a year, with a minimum of 30 days between displays
Community Event Sign	Limited to no more than 4 display periods in a year for a total aggregate display time of 20 days per year

Construction Sign	Erected only after approval of a building permit and must be removed within 7 days of issuance of an occupancy permit or completion of construction, whichever occurs first
Non-Commercial Message Sign	General: No display period limitation Election: Signs of any size related to an election or referendum may be posted in any number from 46 days before the state primary in a state general election year until 10 days following the state general election
Real Estate Sign	All real estate signs may only be erected on the specific property offered for sale or lease or the property holding an open house Real estate for sale/lease signs: Posted for the duration the property is offered for sale or lease, and must be removed within 7 days of closing or lease Real estate open house signs: Only during the day of the open house and must be removed within 2 hours of the end of the event
Temporary Window Sign	Limited to no more than 4 display periods in a year for a total aggregate display time of 60 days per year

2. Exempt temporary signs are subject to the regulations of Table 50-27-3: *Exempt Temporary Sign Regulations*.

TABLE 50-27-3: EXEMPT TEMPORARY SIGN REGULATIONS						
SIGN	PERMITTED DISTRICT OR USE	PERMITTED SIGN TYPE	MAXIMUM SIZE	MAXIMUM HEIGHT (FREESTANDING SIGNS)	REQUIRED SETBACK OR LOCATION (FREESTANDING SIGNS)	NUMBER PER LOT
Attention-Getting Device	Nonresidential uses in MU-C	Freestanding	10 sf	6'	10' from any lot line	1 per lot
Banner (general)	Non-residential uses	Wall or retaining wall	32 sf	(Not applicable)	(Not applicable)	1 per lot
Community Event Sign	All districts and uses	Freestanding or wall	10 sf	6'	10' from any lot line	1 per lot
Construction Sign	All districts and uses	Freestanding or wall	50 sf	6'	10' from any lot line	50 sf total per street frontage
Non-Commercial Message Sign, Election	All districts and uses	Freestanding, wall or retaining wall	No limit	No limit	No limit	No limit
Non-Commercial Message Sign, General	All districts and uses	Freestanding, wall or retaining wall	64 sf	6'	No limit	1 per street frontage
Real Estate Sign	All districts and uses	Freestanding or wall	Residential Districts: 4 sf All Other Districts: 12 sf	5'	10' from any lot line	1 per street frontage
Temporary Window Sign	All nonresidential uses	Window	Temporary & permanent signs (combined) are limited to 30% coverage of each window	(Not applicable)	(Not applicable)	(Not applicable)

50-27 Signs

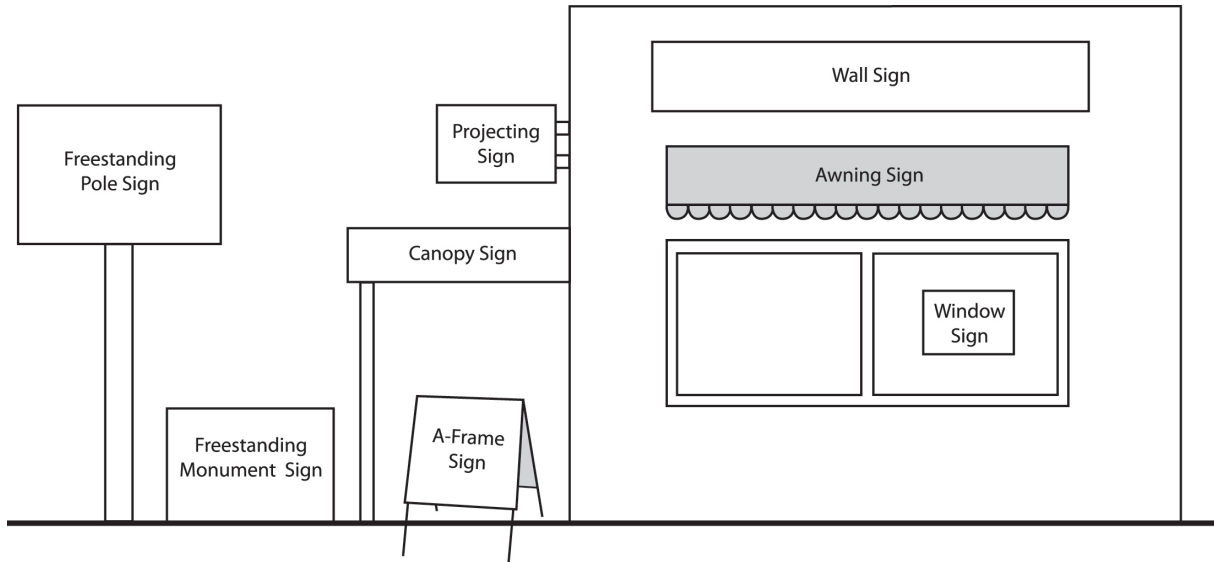

Figure 50-27.6-A: Examples of Common Sign Types.

(Ord. No. 10044, 8-16-2010, § 6; Ord. No. 10204, 3-11-2013, § 1; Ord. No. 10222, 5-13-2013, § 1; Ord. No. 10286, 3-10-2014, §14.)

**50-27.7 Sign types.**

**A. General regulation.**

The following types of signs require a zoning permit before they can be erected on a site. Table 50-27-4: Sign Types – Permit Required: District and Use Permissions describes which sign types are permitted in each district. In many districts, multiple sign types for the same development may be permitted.

<b>TABLE 50-27-4: SIGN TYPES – PERMIT REQUIRED: DISTRICT AND USE PERMISSIONS</b>																								
KEY (REFERENCE TABLE 50-19.8 FOR USES)																								
1 : Residential Uses											3: Commercial Uses													
1A: Multi-Family Dwelling Only											4: Industrial Uses													
2 : Public, Institutional and Civic Uses																								
<i>NOTE: Accessory uses are subject to the home occupation sign standards</i>																								
	R-C	RR-1	RR-2	R-1	R-2	R-P	MU-N	MU-C	MU-I	MU-B	MU-W	MU-P	F-1	F-2	F-3	F-4	F-5	F-6	F-7	F-8	F-9	I-G	I-W	P-1
A-Frame Sign							3	3			3	3	3	3	3	3	3	3	3	3	3			2
Awning	1A 2 3 4	1A 2 3 4	1A 2 3 4	1A 2 3 4	1A 2 3 4	1A 2 3 4	1A 2 3 4	1A 2 3 4	1A 2 3 4	1A 2 3 4	1A 2 3 4	1A 2 3 4	1A 2 3 4	1A 2 3 4	1A 2 3 4	1A 2 3 4	1A 2 3 4	1A 2 3 4	1A 2 3 4	1A 2 3 4	1A 2 3 4	1A 2 3 4	1A 2 3 4	2
Banner - Exhibition	2	2	2	2	2	2	2	2	2	2	2	2	2	2	2	2	2	2	2	2	2	2	2	2
Billboard <sup>1</sup>								3 4		3 4		3 4										3 4		
Canopy	1A 2 3 4	1A 2 3 4	1A 2 3 4	1A 2 3 4	1A 2 3 4	1A 2 3 4	1A 2 3 4	1A 2 3 4	1A 2 3 4	1A 2 3 4	1A 2 3 4	1A 2 3 4	1A 2 3 4	1A 2 3 4	1A 2 3 4	1A 2 3 4	1A 2 3 4	1A 2 3 4	1A 2 3 4	1A 2 3 4	1A 2 3 4	1A 2 3 4	1A 2 3 4	2
Electronic Message Sign <sup>2</sup>	2	2	2	2	2	2	2	2 3 4	2 3 4	2 3 4	2	2 3 4	2	2	2	2	2	2	2 3	2 3 4	4	2	2	2
Freestanding Signs – Pole	2	2	2	2	2	2	2 3 4	2 3 4	2 3 4	2	2 3 4	2 3 4	2 3 4	2 3 4	2 3 4	2 3 4	2 3 4	2 3 4	2 3 4	2 3 4	2 3 4	2 3 4	2 3 4	2
Freestanding Signs – Monument	1 2	1 2	1 2	1 2	1 2	1 2	1 2 3 4	1 2 3 4	1 2 3 4	1 2 3 4	1 2 3 4	1 2 3 4	1 2 3 4	1 2 3 4	1 2 3 4	1 2 3 4	1 2 3 4	1 2 3 4	1 2 3 4	1 2 3 4	1 2 3 4	1 2 3 4	1 2 3 4	2
Marquee							3 4	3 4			3 4	3 4					3 4	3 4	3 4					
Projecting Sign							3 4	3 4	3 4	3 4	3 4	3 4	3 4	3 4	3 4	3 4	3 4	3 4	3 4	3 4	3 4	3 4	3 4	3 4
Scoreboard	2	2	2	2	2	2	2	2	2	2	2	2	2	2	2	2	2	2	2	2	2	2	2	2
Wall Sign	2 3 4	2 3 4	2 3 4	2 3 4	2 3 4	2 3 4	2 3 4	2 3 4	2 3 4	2 3 4	2 3 4	2 3 4	2 3 4	2 3 4	2 3 4	2 3 4	2 3 4	2 3 4	2 3 4	2 3 4	2 3 4	2 3 4	2 3 4	2

<sup>1</sup> Billboards are permitted on any lot within the noted districts, whether developed or undeveloped, unless such lot is developed for a one-family or two-family dwelling.

<sup>2</sup> Filling station uses in any district are permitted to display fuel prices by an electronic message component, and are subject to the restrictions of that section.

Electronic message signs are not allowed in the Historic Canal Park area as identified in UDC Section 50-27.8.C.

Electronic message signs are allowed in the Entertainment District area as identified in UDC Section 50-27.8.B.

**B. A-frame signs.**

A-frame signs are permitted as indicated in Table 50-27-4, subject to the following regulations.

1. A-frame signs are limited to six square feet in area per side and four feet in height. The use of A-frame signs is limited to business hours only and may not be displayed for more than 16 hours in a 24 hour period. Signs must be stored indoors at all other times;
2. An A-frame sign must be placed on the property where the business is located and within ten feet of the primary entrance of the business or on the right-of-way in front of property. A-frame signs must provide an unobstructed sidewalk width of at least five feet for pedestrian passage and must not interfere with pedestrian traffic or violate standards of accessibility as required by the ADA or other accessibility codes;
3. The permit applicant must provide and maintain in force a certificate of insurance, in a form approved by the city, that evidences that the applicant has in force insurance in the minimum amounts required by the city for bodily injuries or property damage in any one year protecting such person or organization and the City against liability for injuries or damages resulting from the placement of such objects or materials in the public right-of-way. Proof of insurance must be renewed on an annual basis;

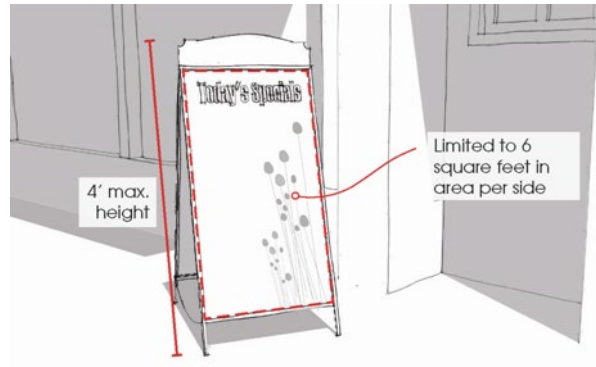

### C. Awning.

Awnings without printing, with the exception of a street address number (number only), are considered an architectural feature and are not regulated by this Section. This Section regulates awning signs, which are used to identify a use by name or logo, the goods or services offered on-site, and similar sign information. Awning signs are permitted as indicated in Table 50-27-4, subject to the following regulations:

1. Awning signs must maintain a minimum vertical clearance of seven feet six inches (7' 6");
2. Awning signs must be located a minimum of 18 inches from the back of curb;
3. Awning signs must comply with Minnesota State Building and Fire codes, including provisions for encroachment into the public right-of-way, structural requirements, sprinkler protections and similar regulations;
4. Awning signs must be made of a durable, weather-resistant material like canvas, canvas-like material, nylon, vinyl-coated fabric or metal. Solid, flat-roofed awnings may also be made out of finished wood, wood and plastic composites, metal or metal cladding, stucco or EIFS;
5. Printing on any awning sign is limited to 30 percent of the surface area;
6. Awning signs are permitted lettering attached to and located above the top of a solid awning to a maximum height of 24 inches. Signs mounted to solid, flat roofed awnings are limited to individually-mounted letters with internal illumination (if illuminated) or a sign board with external illumination – no internally illuminated cabinet signs;
7. Awning signs may illuminate the printed area of the awning with gooseneck or similar external illumination. Back-lit awnings are prohibited;
8. Under-awning signs are permitted subject to the following:
  - (a) Under-awning signs must be attached to the underside of an awning. Under-awning signs must not project beyond the awning;
  - (b) Under-awning signs must maintain a minimum vertical clearance of seven feet;
  - (c) A maximum of one under-awning sign is permitted per business establishment with frontage on the street where the awning is mounted;
  - (d) Each under-awning sign is limited to a maximum of six square feet;
  - (e) Under-awning signs must be securely fixed to the awning with metal supports;
  - (f) Under-awning signs must be made of wood, metal or plastic;
9. A sign permit is required for recovering or resurfacing an existing awning;

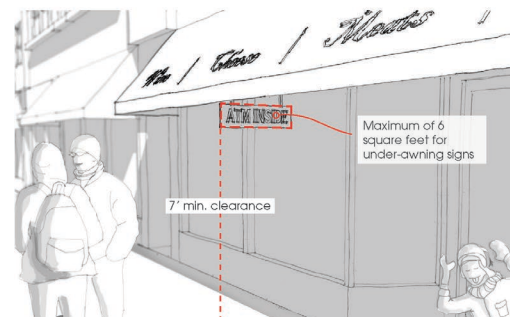
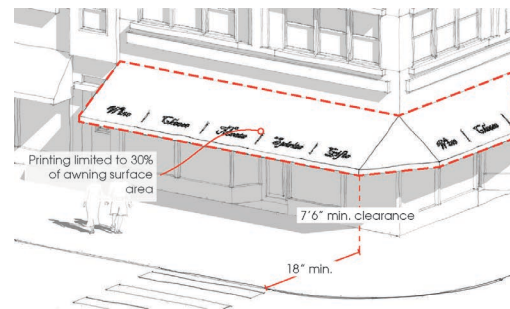

**D. Exhibition banners.**

Exhibition banners are intended to be used in conjunction with a special exhibit for an educational facility, government building, museum, library or art gallery, or religious assembly. Exhibition banners are permitted for events and exhibitions as indicated in Table 50-27-4, subject to the following regulations:

1. Each use is permitted up to six exhibition banners during one display period. The display period is defined as the combined period of 30 days prior to the opening of the exhibit, the run of the exhibit, and for 14 days following the close of the exhibit. In no event may the display of exhibition banners exceed four months in any calendar year;
2. Exhibition banners must be made of a durable, weather-resistant material like canvas, nylon or vinyl-coated fabric;
3. Each exhibition banner is limited to a maximum sign area of 200 square feet;
4. Exhibition banners must be securely and tautly attached to the wall of the structure and no exhibition banner may be located higher than the roofline;

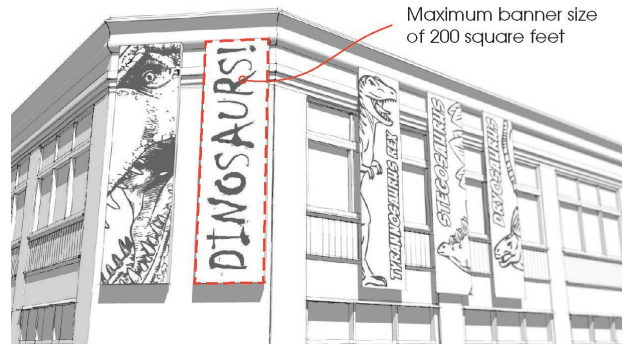

**E. Billboard.**

The following types of signs require a zoning permit before they can be erected on a site;

1. Billboards are permitted as indicated in Table 50-27-4 subject to the following regulations. However, billboards are only permitted in the MU-B and I-G districts with the use of an exception credit (Section 50-38.7). Billboards are also further restricted by the requirements of Minnesota State Statute Section 173.08, Subdivision 2, as amended from time to time;
2. The maximum sign area for a billboard is 700 square feet;
3. Billboards adjacent to on-grade roadways are limited to a maximum height of 25 feet. Billboards adjacent to grade separated/elevated roadways are permitted to measure the 25 foot height from the roadbed crown to the tallest projection of the structure. This measurement is taken at a perpendicular angle between the grade separated/elevated roadway and the sign location;
4. Billboards may only be mounted as freestanding pole signs. However, when an exception credit is used, billboards may be wall-mounted and are limited to the wall sign area allowed for that district;

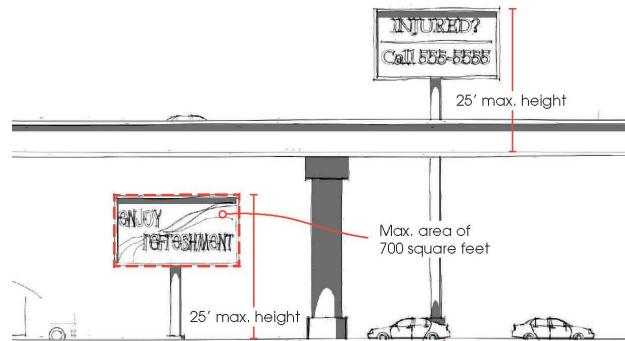



5. Billboards are required to be spaced 500 feet apart, subject to the following:
- Billboards located along Interstate Highway No. 35 and Interstate Highway No. 535 must be spaced 800 feet apart, unless erected under an exception credit in which case only the 500 foot spacing is required;
  - Spacing is measured along the nearest edge of the right-of-way pavement to which the billboard is displayed and between points directly opposite the center of the billboard;
  - Spacing requirements apply only to billboards located on the same side of the same highway.
  - Multi-faced or back-to-back billboards, up to a maximum of a five foot separation between sign faces, are considered one billboard;

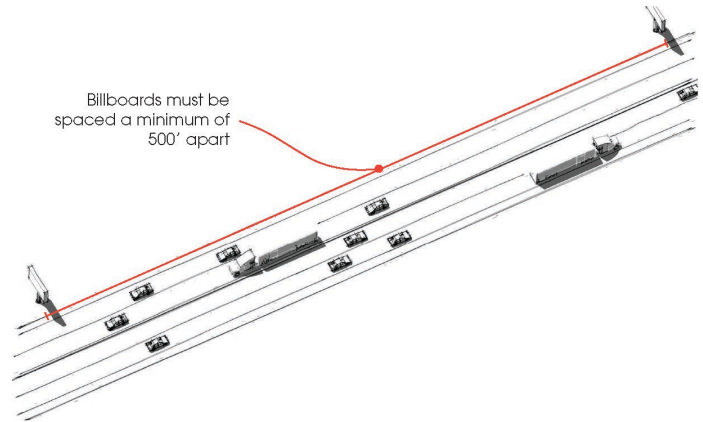

6. Electronic billboards are permitted only in the MU-C, MU-B, and I-G districts. Electronic billboards are subject to the following regulations:
- An electronic billboard may only be erected if one of the following criteria is met:
    - The electronic billboard is constructed using exception credits. The number of exception credits, in square footage, must equal three times the square footage of the electronic billboard to be constructed;
    - Nonconforming billboards of a total square footage are removed in an amount equal to three times the square footage of the electronic billboard to be constructed;
  - Each message displayed on an electronic billboard must be static or depicted for a minimum of eight seconds. Any scrolling, flashing or movement of the message is prohibited;
  - The maximum brightness of an electronic billboard is limited to 5,000 nits or 464 candelas per square foot during daylight hours, and 500 nits or 46 candelas per square foot between dusk to dawn. The billboard must have an automatic dimmer control that produces a distinct illumination change from a higher allowed illumination level to a lower allowed level for the time period between one-half hour before sunset and one-half hour after sunrise;
7. No off-premises sign or billboard in excess of 60 square feet shall be erected or maintained in any area shown on the maps in Exhibit 50-27.8-1;

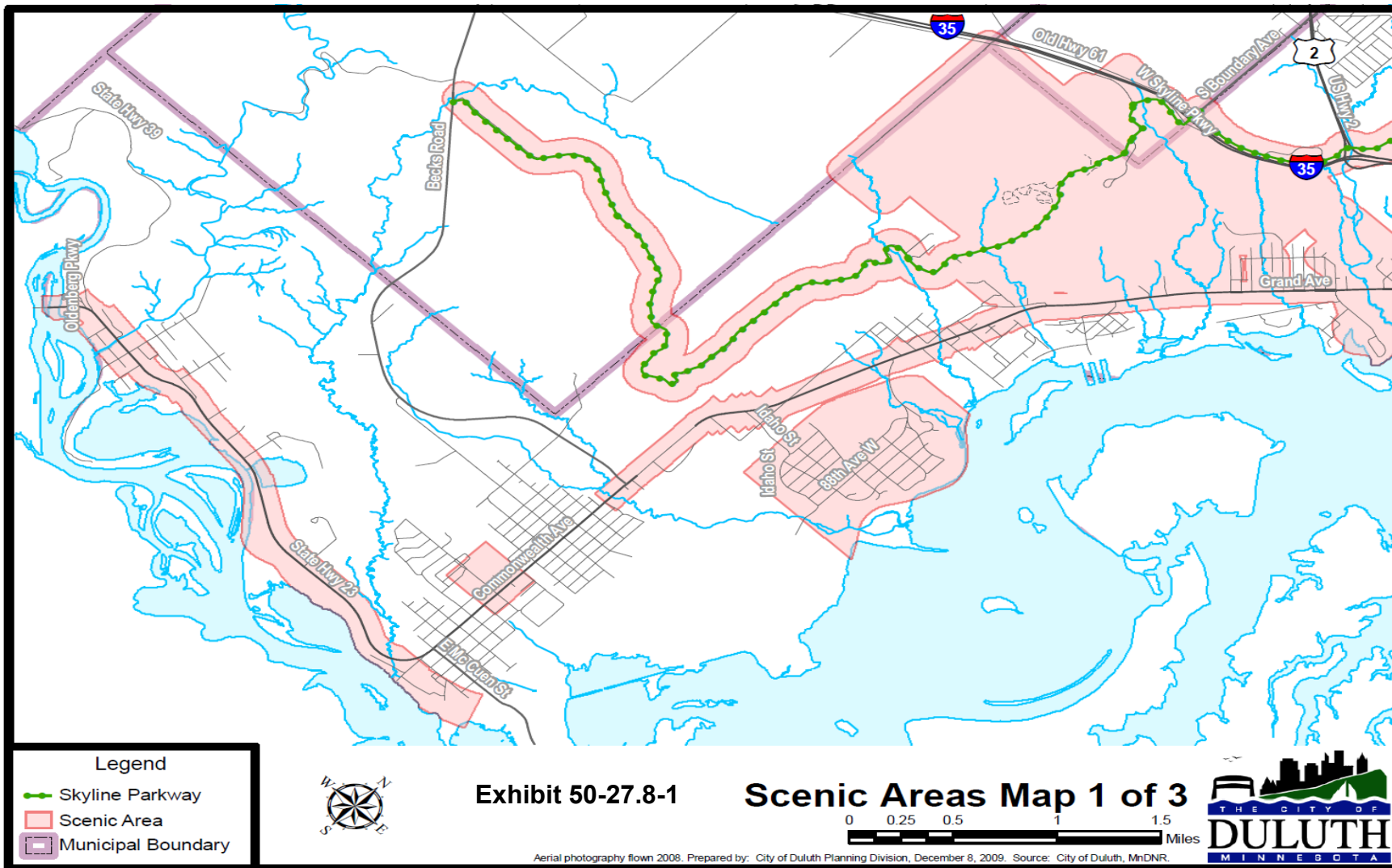

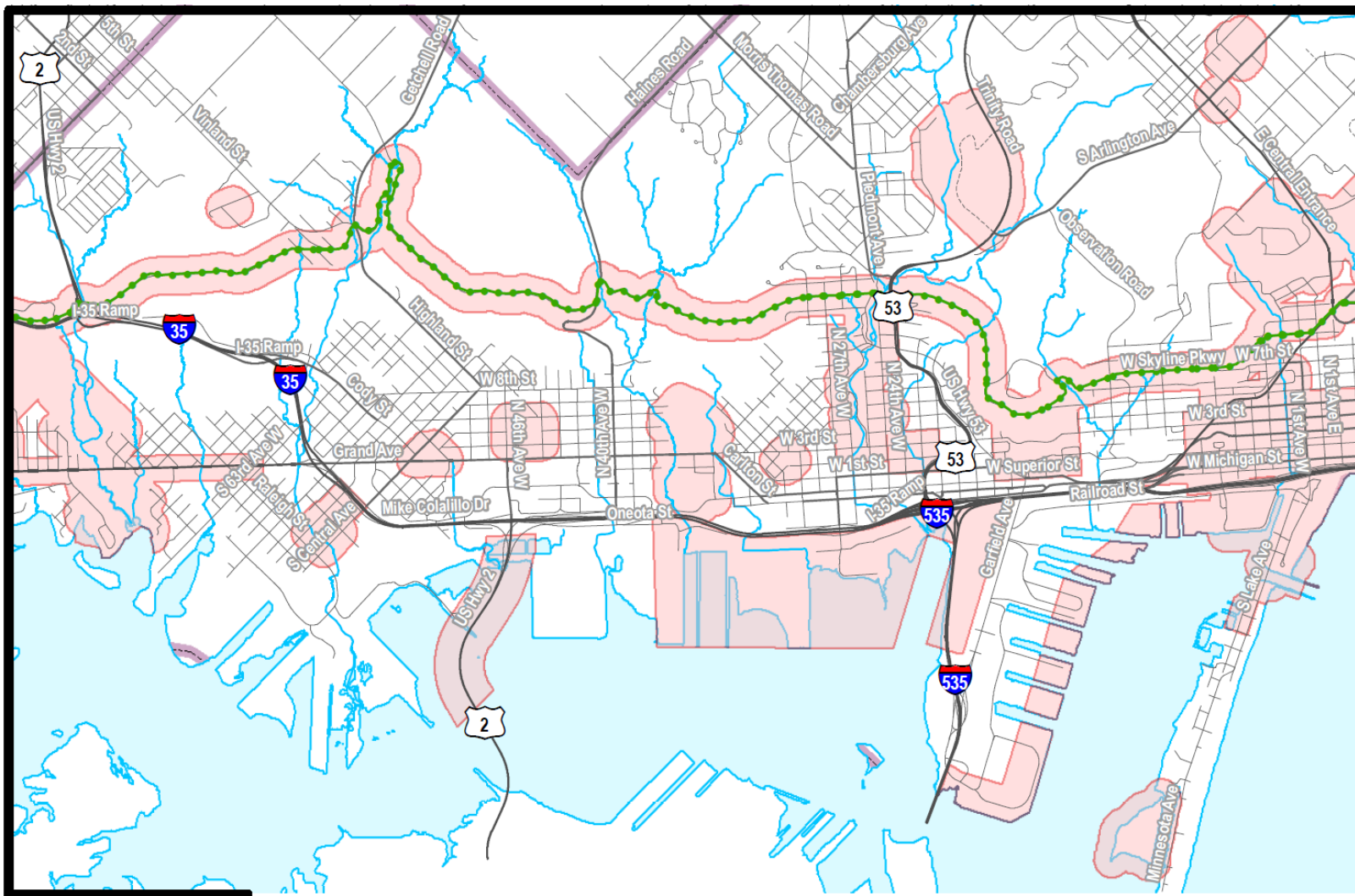

**Legend**

- Skyline Parkway
- Scenic Area
- Municipal Boundary

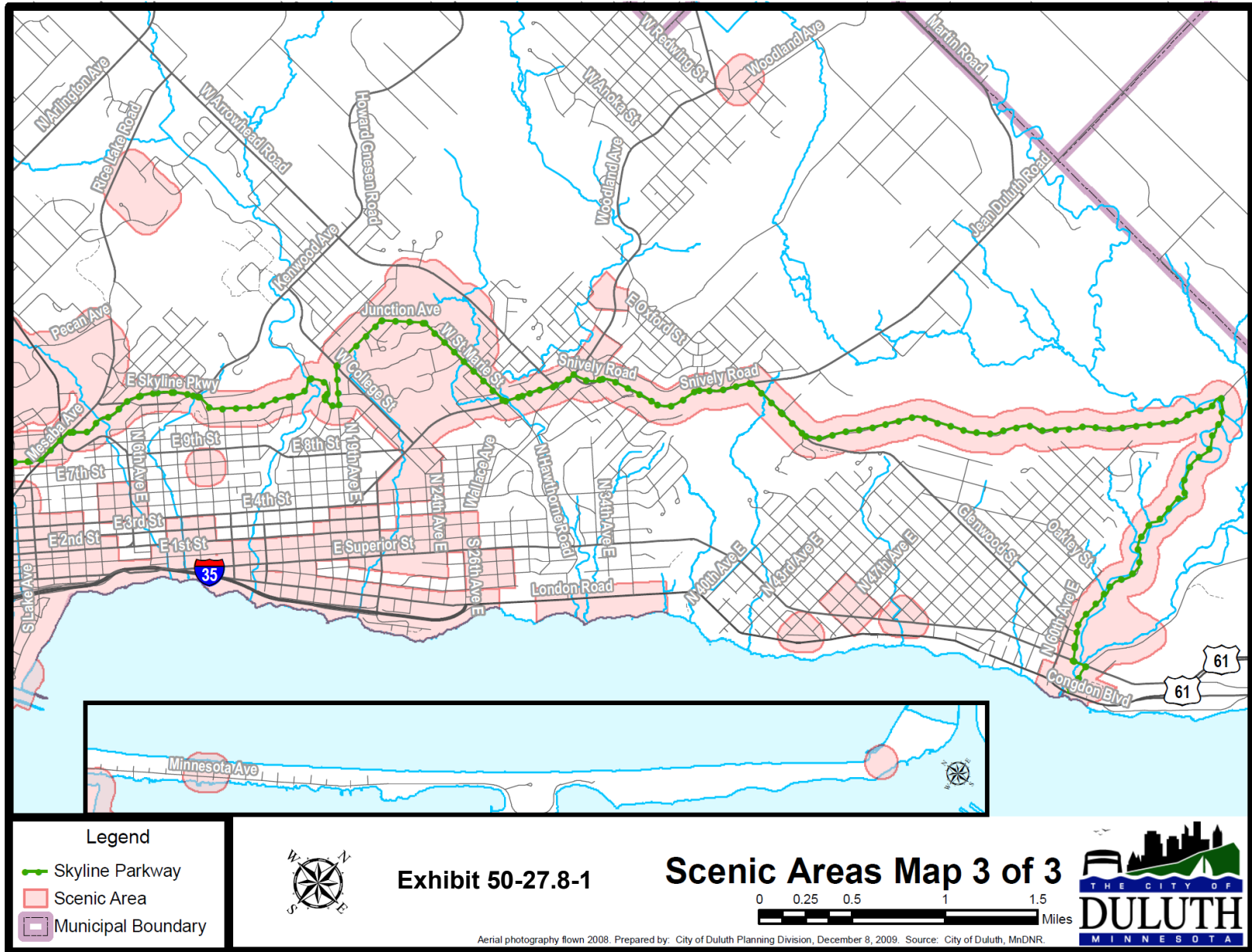

**Exhibit 50-27.8-1**

**Scenic Areas Map 2 of 3**



Aerial photography flown 2008. Prepared by: City of Duluth Planning Division, December 8, 2009. Source: City of Duluth, MnDNR.



## F. Canopy.

Canopies without printing, with the exception of a street address number (number only), are considered an architectural feature and are not regulated by this Section. This Section regulates canopy signs, which are used to identify a use by name or logo, the goods or services offered on-site, and similar sign information. Canopy signs are permitted as indicated in Table 50-27-4 subject to the following regulations:

1. Canopy signs must maintain a minimum vertical clearance of seven feet six inches (7' 6");
2. Canopy signs must be located at least 18 inches from the back of curb. Support posts must maintain a minimum separation of five feet between posts and between the posts and any building wall. No obstructions are permitted within this area;
3. Canopy signs must comply with Minnesota State Building and Fire codes, including provisions for encroachment into the public right-of-way, structural requirements, sprinkler protections and similar regulations;
4. Canopy signs must be made of a durable, weather-resistant material like canvas, canvas-like material, nylon, vinyl-coated fabric or metal. Solid, flat-roofed canopies may also be made out of finished wood, wood and plastic composites, metal or metal cladding, stucco or EIFS;
5. Printing on any canopy sign is limited to 30 percent of the surface area. Signs mounted to solid, flat roofed canopy are limited to individually-mounted letters with internal illumination (if illuminated) or a sign board with external illumination – no internally illuminated cabinet signs;
6. Canopies may include underside, external illumination;
7. Under-canopy signs are permitted subject to the following:
  - (a) Under-canopy signs must be attached to the underside of a canopy. Under-canopy signs must not project beyond the canopy;
  - (b) Under-awning signs must maintain a minimum vertical clearance of seven feet;
  - (c) A maximum of one under-canopy sign is permitted;
  - (d) Each under-canopy sign is limited to a maximum of six square feet;
  - (e) Under-canopy signs must be securely fixed to the awning with metal supports;
  - (f) Under-awning canopy must be made of wood, metal or plastic;

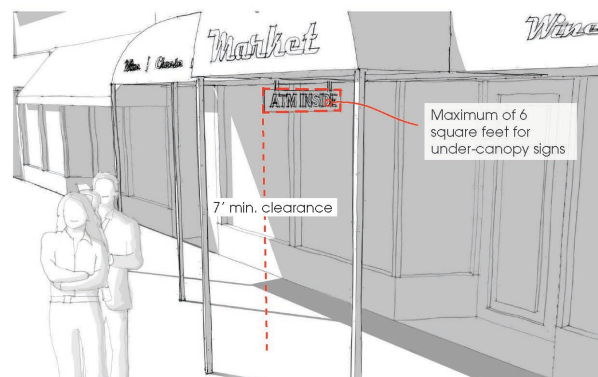
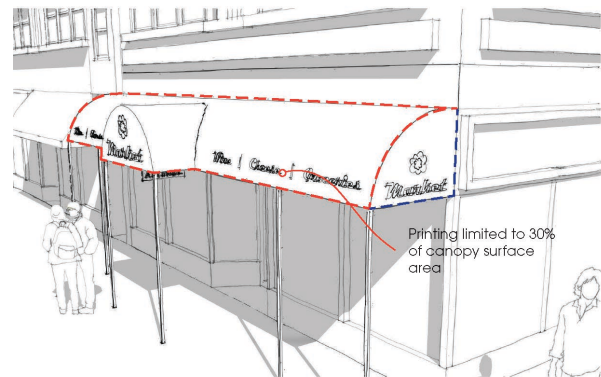
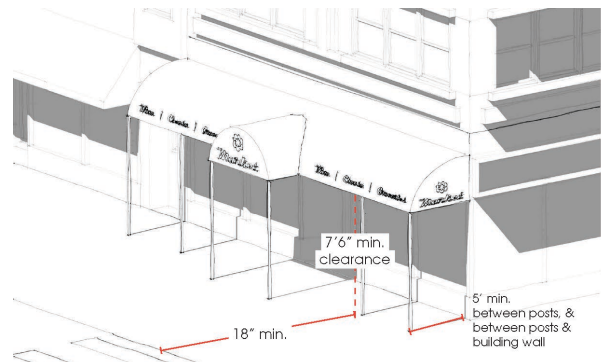

### G. Electronic message sign.

Electronic message signs are permitted as indicated in Table 50-27-4 subject to the following regulations. However, all filling stations in any district are permitted to display fuel prices by an electronic message component. Such component must only display numerical fuel prices and must be static.

1. Only one electronic message sign per lot is permitted;
2. Each message or image displayed on an electronic message sign must be static or depicted for a minimum of eight seconds. Any scrolling, flashing or movement of the message is prohibited;
3. The maximum brightness of an electronic message sign is limited to 5,000 nits or 464 candelas per square foot during daylight hours, and 500 nits or 46 candelas per square foot between dusk to dawn. The sign must have an automatic dimmer control that produces a distinct illumination change from a higher allowed illumination level to a lower allowed level for the time period between one-half hour before sunset and one-half hour after sunrise;
4. Electronic message signs are permitted as part of a freestanding sign, wall sign or marquee and, in addition, are subject to the requirements for those sign types;
5. Electronic message signs must be integrated into the larger sign structure and must include the name of the use as a non-electronic component as part of the sign structure. Electronic message signs are limited to a maximum of 60 percent of the sign area of the freestanding or wall sign with which it is integrated;
6. Electronic message signs cannot display any off-premises commercial advertising;
7. Electronic display screens are prohibited;

### H. Freestanding signs-pole and monument.

Freestanding signs are permitted as indicated in Table 50-27-4, subject to the following regulations:

1. Freestanding sign maximum height and sign areas are as indicated in Table 50-27-5. Freestanding signs must be constructed of solid or composite finished wood, metal, masonry, neon, glass or nonwoven plastic;
2. Only one freestanding sign, either pole or monument, is permitted per street frontage of a lot. For each additional 200 feet of street frontage, above an initial 200 feet of frontage, an additional freestanding sign, either pole or monument, is permitted, up to a maximum of three freestanding signs;
3. All freestanding signs over seven feet in height must submit construction plans prepared by a design professional licensed in Minnesota that comply with the requirements of the Minnesota State Building Code;
4. No part of a freestanding sign may project into, over or otherwise encroach on a public right-of-way;
5. A freestanding pole sign must maintain a minimum vertical clearance of eight feet. When the pole structure of a freestanding pole sign is wrapped in any decorative material, the decorative pole wrapping must be permanently installed. Decorative wrapping shall not be closer than three feet to the property line, and shall not be wider than 25 percent of the sign face. No temporary signs may be attached to the pole of a freestanding pole sign;
6. Freestanding monument signs may be internally or externally illuminated. If externally illuminated, all light must be directed onto the sign face. Freestanding pole signs may only be internally illuminated;

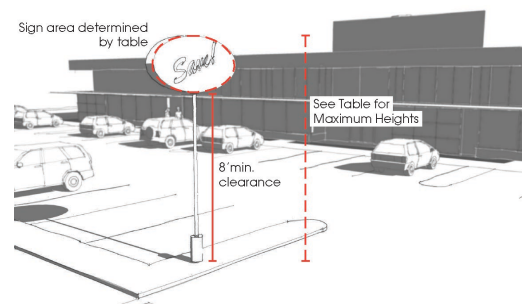
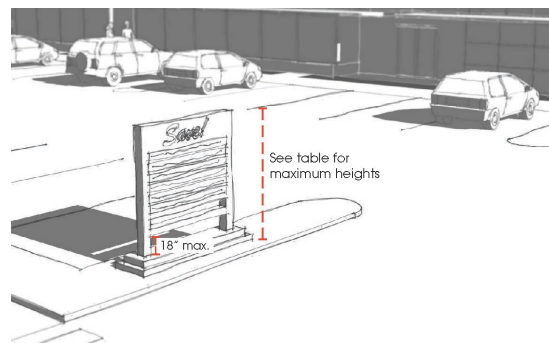

<b>TABLE 50-27-5: FREESTANDING SIGN REGULATIONS</b>			
<b>DISTRICT</b>	<b>SIGN AREA</b>	<b>POLE SIGN</b>	<b>MONUMENT SIGN</b>
	<b>Maximum Sign Area (Square Feet)</b>	<b>Maximum Sign Height (Feet)</b>	<b>Maximum Sign Height (Feet)</b>
<b>R-C</b>	<b>42 sf</b>	<b>17</b>	<b>6</b>
<b>RR-1</b>	<b>42 sf</b>	<b>17</b>	<b>6</b>
<b>RR-2</b>	<b>42 sf</b>	<b>17</b>	<b>6</b>
<b>R-1</b>	<b>42 sf</b>	<b>17</b>	<b>6</b>
<b>R-2</b>	<b>42 sf</b>	<b>17</b>	<b>6</b>
<b>R-P</b>	<b>42 sf</b>	<b>17</b>	<b>6</b>
<b>MU-N</b>	<b>42 sf</b>	<b>17</b>	<b>6</b>
<b>MU-C*</b>	<b>60 sf</b>	<b>25</b>	<b>8</b>
<b>MU-I*</b>	<b>50 sf</b>	<b>25</b>	<b>8</b>
<b>MU-B*</b>	<b>50 sf (Monument)</b>	Prohibited	<b>8</b>
<b>MU-W*</b>	<b>50 sf</b>	<b>20</b>	<b>6</b>
<b>MU-P*</b>	<b>60 sf</b>	<b>25</b>	<b>8</b>
<b>F-1</b>	<b>42 sf</b>	<b>17</b>	<b>6</b>
<b>F-2</b>	<b>42 sf</b>	<b>17</b>	<b>6</b>
<b>F-3</b>	<b>42 sf</b>	<b>17</b>	<b>6</b>
<b>F-4</b>	<b>42 sf</b>	<b>17</b>	<b>6</b>
<b>F-5</b>	<b>42 sf</b>	<b>17</b>	<b>6</b>
<b>F-6</b>	<b>42 sf</b>	<b>17</b>	<b>6</b>
<b>F-7</b>	<b>42 sf</b>	<b>17</b>	<b>6</b>
<b>F-8</b>	<b>42 sf</b>	<b>15</b>	<b>6</b>
<b>F-9</b>	<b>60 sf</b>	<b>25</b>	<b>8</b>
<b>I-G*</b>	<b>60 sf</b>	<b>25</b>	<b>8</b>
<b>I-W*</b>	<b>60 sf</b>	<b>25</b>	<b>8</b>
<b>P-1</b>	<b>42 sf</b>	<b>17</b>	<b>6</b>

\*Freestanding Pole and Monuments Signs in the MU-I, MU-B and MU-W zones are allowed a maximum of 50 sq ft. However, for sites with lot frontage that exceeds 250 lineal feet, the maximum size area of the sign may equal up to 20 percent of the lineal street frontage on the street nearest the sign, up to a maximum sign area of 100 sq ft.

\*Freestanding Pole and Monument Signs in the MU-C, MU-P, I-G, and I-W zones are allowed a maximum of 60 square feet. However, for sites with lot frontage that exceeds 300 lineal feet, the maximum size area of the sign may equal up to 20 percent of the lineal street frontage on the street nearest the sign, up to a maximum sign area of 150 square feet.

**I. Marquee.**

Marquees are permitted as indicated in Table 50-27-4, subject to the following regulations:

1. Marquees must be supported solely by the building to which they are attached. No exterior columns or posts are permitted as supports;
2. No marquee may be erected on any building or other structure of wood frame construction;
3. The roof of a marquee may not be used for any purpose other than to form and constitute a roof and must be constructed of noncombustible material;
4. Water from the roofs of a marquee may not drain, drip or flow onto the surface of a public sidewalk. Sufficient downspouts, drains and gutters must be installed as part of each marquee to prevent water from flowing onto the surface of a public sidewalk;
5. Marquees must be erected over a building entrance and are limited to the width of the building entrance. An additional five feet on each side of the entrance doors covered by the marquee is permitted;
6. All marquees must maintain a minimum vertical clearance of eight feet and the roof of the marquee structure must be erected below the second floor window sill. Marquees may encroach up to 18 inches from the back of curb;
7. Marquees are permitted lettering attached to and located above the roof of a marquee to a maximum height of 24 inches;
8. Marquees may be internally illuminated. External Illumination is prohibited;

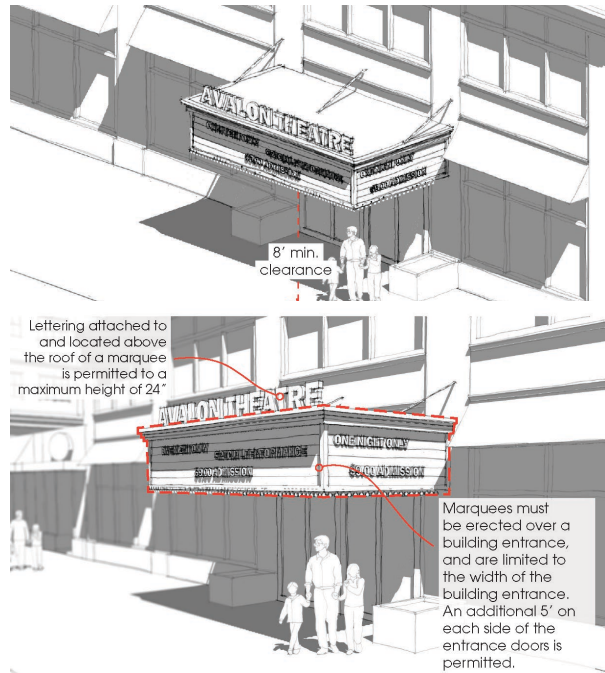



**J. Projecting signs.**

Projecting signs are permitted as indicated in Table 50-27-4, subject to the following regulations:

1. Projecting sign maximum area is as indicated in Table 50-27-6;
2. One projecting sign is permitted per establishment with frontage on a street. For a corner lot, one projecting sign is permitted for each street frontage. Projecting signs must be above or adjacent to the building entrance or, if a corner lot, the corner of the building;
3. Projecting signs may not project more than six feet from the face of the building to which they are attached, including the area between the sign and the face of the building;
4. Projecting signs must maintain a minimum vertical clearance of eight feet. No projecting sign affixed to a building may project higher than the building height, including the sign support structure;
5. Projecting signs, including frames, braces, and supports, must be designed by a licensed structural engineer or manufacturer. No projecting sign may be secured with wire, chains, strips of wood or nails nor may any projecting sign be hung or secured to any other sign. Any movable part of a projecting sign, such as the cover of a service opening, must be securely fastened by chains or hinges;
6. Projecting signs must be constructed of wood, metal, durable, weather-resistant material like canvas, canvas-like material, nylon or vinyl-coated fabric, or plastic. Projecting signs constructed of material must be mounted so that they are held taut between support posts;
7. Projecting signs may be internally or externally illuminated. If externally illuminated, all lighting must be directed onto the sign face from above;
8. Maximum projecting sign areas are provided in Table 50-27-6: *Projecting Sign Regulations*;
9. Projecting signs erected on properties within the Entertainment District and Historical Canal Park are subject to additional requirements as provided in 50-27.8;

TABLE 50-27-6: PROJECTING SIGN REGULATIONS	
DISTRICT	MAXIMUM AREA
R-C	Prohibited
RR-1	Prohibited
RR-2	Prohibited
R-1	Prohibited
R-2	Prohibited
R-P	Prohibited
MU-N	36 sf
MU-C	48 sf
MU-I	48 sf
MU-B	48 sf
MU-W	36 sf
MU-P	48 sf
F-1	36 sf
F-2	36 sf
F-3	36 sf
F-4	36 sf
F-5	36 sf
F-6	36 sf
F-7	36 sf
F-8	48 sf
F-9	48 sf
I-G	48 sf
I-W	48 sf
P-1	Prohibited

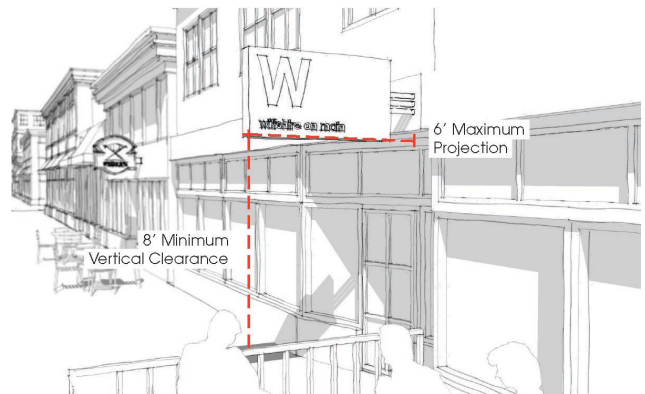

**K. Scoreboard and outfield signs.**

1. Scoreboards and outfield signs are permitted as indicated in Table 50-27-4, subject to the following regulations. Such signs are further restricted to recreational playing fields only;
2. Scoreboards must be constructed as a freestanding pole sign, no more than 300 square feet in sign area and 25 feet in height;
3. The score-keeping portion of the scoreboard may utilize an electronic message component;
4. If the scoreboard cannot be viewed from any adjacent right-of-way as measured along 500 foot sight lines from the scoreboard, up to 30 percent of the sign area may be used for off-premises advertising. If the scoreboard can be viewed from any adjacent right-of-way, up to 25 percent of the sign area may be used for off-premises advertising;
5. There is no limit on the number of outfield advertising signs so long as no such signs are visible from an adjacent right-of-way. No permit is required for outfield advertising signs;
6. Scoreboards and outfield signs that are part of a sports stadium as a principal use are considered part of the structure and not subject to these standards;

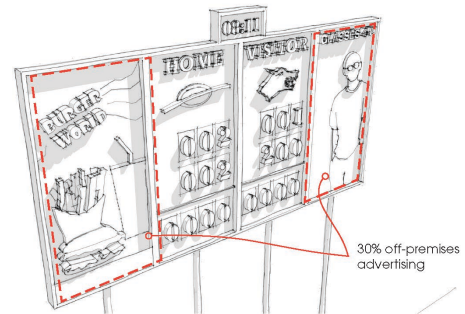
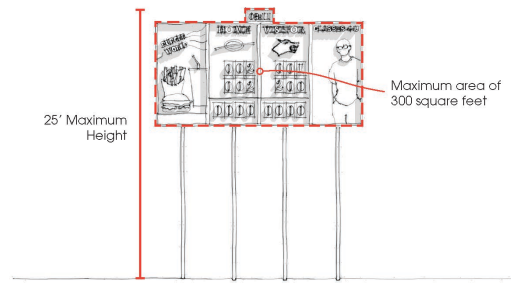

**L. Wall signs.**

Wall signs are permitted as indicated in Table 50-27-4, subject to the following regulations.

1. The maximum size of a wall sign is established at two square feet per linear foot of building façade where the wall sign will be mounted or 40 square feet, whichever is greater;
2. In addition, any structure over seven stories in height is permitted one additional wall sign per façade to identify the building, that must be placed within the top 20 feet of the structure and cannot cover any fenestration or architectural features. The maximum size is established at two square feet per linear foot of building façade, measured at the roof line, where the wall sign will be mounted;
3. Wall signs may be internally or externally illuminated. If externally illuminated, all light must be directed onto the sign face from above;
4. Wall signs must be safely and securely attached to the building wall. Wall signs must be affixed flat against the wall and must not project more than 18 inches from the building wall;
5. If a wall sign projects more than two inches from the surface, a minimum vertical clearance of eight feet is required;
6. No wall sign mounted on a structure may project above the roof of the structure to which it is attached, including the sign support structure. Wall signs may be mounted on a parapet wall when such parapet is consistent with the architectural design of the structure and/or the larger development, and such parapet wall is constructed of the same primary building materials as the structure, excluding any accent materials. When attached to a parapet wall, wall signs may not project more than eight feet above the roof of the structure, or 15 feet above the roof of the structure on properties zoned MU-C;

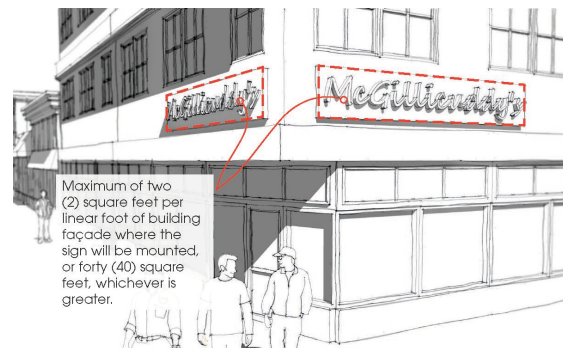

7. Wall signs must be constructed of wood, brick, metal or plastic. Wall signs of durable, weather-resistant material like canvas, canvas-like material, nylon or vinyl-coated fabric are also permitted but the signs must be held taught to the building with no sags or wrinkles and the mounting devices must be concealed by a frame that covers the entire perimeter of the banner;
8. Wall signs must not cover windows, doors or architectural features. However, wall signs are permitted on architectural appurtenances, such as chimneys or penthouses, which are part of the original structure;
9. Ghost signs are considered wall signs. Existing ghost signs are exempt from these requirements and deemed conforming. Ghost signs may be maintained and repainted but no new information or images may be added to the existing sign. No new wall signs may be painted over ghost signs. (Ord. No. 10044, 8-16-2010, § 6; Ord. No. 10204, 3-11-2013, § 1; Ord. No. 10222, 5-13-2013, § 1; Ord. No. 10286, 3-10-2014, § 15; Ord. No. 10338, 11-24-2-14, § 3.)



**50-27.8 Areas of special sign control.****A. Purpose.**

The city recognizes that certain areas present a unique character that could be strengthened and enhanced with the application of specific sign standards. These commercial areas are:

1. Entertainment districts:
  - (a) Lake Avenue South from Railroad Street to lift bridge;
  - (b) East Superior Street from Lake Avenue to 9th Avenue East;
2. Historic Canal Park: Canal Park Drive from Lake Place Drive to canal;

**B. Entertainment district standards.**

1. All projecting signs are permitted a maximum sign area of 36 square feet, unless the zoning district allows a greater maximum sign area;
2. Marquee signs are permitted;
3. Electronic message signs are permitted as components of wall, marquee or freestanding signs, subject to the electronic message sign regulations;

**C. Historical Canal Park standards.**

1. All projecting signs are limited to a maximum sign area of 12 square feet;
2. All projecting signs may only be externally illuminated from above;
3. All signs must be constructed of wood, brick or metal. Individually mounted plastic letters are permitted for wall signs if wholly covered with opaque paint;
4. All signs are limited to colors from the following color palette. Photographs of the color palette swatches are provided for illustrative purposes only. Applicants may view the original palette at the city of Duluth. For the purposes of this ordinance, the specific colors are provided in two types. The first describes the paint colors originally cited in the DWMX District, which are a series of Ace Hardware paint colors. A general Pantone equivalent is also provided, which are the "uncoated" Pantone PMS colors. Pantone is a color system used in a variety of industries, primarily printing, and occasionally in the manufacture of colored paint, fabric, and plastics. Applicants may consult with the land use supervisor to determine the final colors to be used in the sign, which must meet the general color requirements of this Section.

(Ord. No. 10044, 8-16-2010, § 6; Ord. No. 10204, 3-11-2-13, § 1; cited only in Ord. No. 10222, 5-13-2013, § 1.)

### COLOR PALETTE

Ace Hardware Paint Color	General Pantone Color (Uncoated) Equivalent	Ace Hardware Paint Color	General Pantone Color (Uncoated) Equivalent
	<b>Far Horizon</b> 65A-2P 649		<b>Mirage Lake</b> 65A-3P 650
	<b>Cocoa Parfait</b> 25C-1P 4755		<b>Malibu Sand</b> 25B-2T 466
	<b>Tuxedo Gray</b> 78C-1P 650		<b>Gray Tweed</b> 78C-3D 5425
	<b>Gray Duck</b> 73C-2P 651		<b>Symphony Blue</b> 73C-4D 5415
	<b>Bobby Blue</b> 66B-2T 637		<b>Black Magic</b> 65A-1A Process Black
	<b>Riviera Sky</b> 75B-3D 646		<b>Spectrum Blue</b> 67B-4D 3005
	<b>Tahiti Blue</b> 58C-2T 630		<b>Calico Blue</b> 75A-1A 2955
	<b>Green Stone</b> 60C-2T 623		<b>Nanking Blue</b> 66B-4D 313
	<b>Sea Vista</b> 56C-2T 629		<b>Veridiam</b> 60C-4D 371
	<b>Aqua Pool</b> 56C-3D 326		<b>Gemstone</b> 56C-4D 3292
Ace Hardware Paint Color	General Pantone Color (Uncoated) Equivalent	Ace Hardware Paint Color	General Pantone Color (Uncoated) Equivalent
	<b>Cane</b> 36B-1T 726		<b>Harvest</b> 36B-2D 727
	<b>Peach Velvet</b> 15B-2T 699		<b>Dawn Sun</b> 15B-3D 708
	<b>Coral Reef</b> 7B-2T 701		<b>Spectrum Red</b> 5A-1A 186
	<b>Pagoda Red</b> 5C-4D 703		<b>War Dance</b> 14A-1A 188
	<b>Blushing Pink</b> 4C-2T 673		<b>Rosalind</b> 4C-4D 207
	<b>Tarragon</b> 25C-3D 465		<b>Stratum Rock</b> 38A-1A 462
	<b>Lobster Bisque</b> 16C-1P 699		<b>Tile Tan</b> 16C-3D 486
	<b>Ripe Peach</b> 22C-2T 722		<b>Bright Sienna</b> 22C-4D 723
	<b>Tile Tan</b> 16C-3D 486		<b>Really Rust</b> 22A-1A 484
	<b>Bracken Brown</b> 25C-2T 406		<b>Tobacco Gold</b> 47A-1A 4495

**50-27.9 Master sign plan.**

---

- A. Following the effective date of this Section, an applicant is required to submit a master sign plan for any new commercial multi-tenant building or development that includes non-residential uses, including mixed-use development, for review and approval by the planning commission. The planning commission shall review the application, conduct a public hearing pursuant to Section 50-37.1.I, with public notice as required by Section 50-37.1.H, and make a decision to adopt, adopt with modifications, or deny the application;
- B. The master sign plan must provide a coordinated design for all building-mounted signs including, at a minimum, criteria and specifications for sign locations, general range of sign area, and lighting. All freestanding signs must be shown on the sign plan, including size, location and lighting;
- C. Once approved, signs erected within the multi-tenant development must follow the master sign plan;
- D. The review and approval process for a master sign plan does not allow for variations to the requirements of this Section. (Ord. No. 10204, 3-11-2013, § 1; cited only in Ord. No. 10222, 5-13-2013, § 1.)

**50-27.10 Campus sign plan.**

---

- A. The city recognizes that university or college or hospital campuses have unique sign needs that may need to depart from the requirements of this Section. In such cases, the planning commission may recommend and city council may approve such sign standards for temporary and permanent signs through the review and adoption of a campus sign plan;
- B. A campus sign plan may be applied for by a university or college or hospital campus a minimum of two acres in size. In calculating the area, the entire area does not have to be contiguous and may be separated by public rights-of-way or by individual parcels not owned by the institution. However, the entire area must function as a connected campus;
- C. As part of the establishment of a campus sign plan, a comprehensive sign plan must be submitted. The comprehensive sign plan must describe the sign standards for the campus, including all exceptions to the requirements of this Section. A campus sign plan may be more permissive than the standards of this section. Directional signs within the campus may be described generally by sign area and height and general locations;
- D. The planning commission shall review the application, conduct a public hearing pursuant to Section 50-37.1.I, with public notice as required by Section 50-37.1.H, and make a decision to adopt, adopt with modifications, or deny the application;
- E. Alternately, a campus sign plan may be incorporated into the review and approval process of the district plan option of the MU-I District. (Ord. No. 10204, 3-11-2013, § 1; cited only in Ord. No. 10222, 5-13-2013, § 1.)

**50-27.11 Classic signs.**

---

**A. Purpose.**

Because the city recognizes that certain existing signs do not conform with this Chapter but are particularly unique and/or have historic value, including signs for products or businesses that are no longer located on-site, the classic sign designation is established where the city can designate certain signs as classic signs. Once designated, the classic sign is deemed conforming, and thus is no longer nonconforming, provided the sign is maintained in good condition and its physical integrity remains intact. Any sign designated on the national historic register is automatically considered a classic sign under this Section;

**B. Eligibility.**

1. An owner of a sign, or the city may apply for designation of an existing sign as a classic sign. Classic signs are exempt from area, setback, height, lighting, movement, placement, type, content, and construction materials requirements of this Section;
2. To qualify for designation as a classic sign, the sign must:
  - (a) Be at least 25 years old or an exact replica of an original sign where the combined age of the duplicate and original sign is at least 25 years;
  - (b) Possess unique physical design characteristics, such as configuration, message, color, texture, etc.;
  - (c) Be of significance to the city, regardless of the use identified by the sign;
3. A sign designated a classic sign may remain on the premises even if the original use to which the sign relates is no longer located on the premises. A designated classic sign may also be moved to a new structure;

**C. Application.**

The application for classic sign status must be made to the land use supervisor, who will schedule a public hearing. The planning commission may approve or deny the application;

**D. Maintenance.**

The owner of a classic sign must ensure that the sign is not structurally dangerous, a fire hazard, an electrical shock hazard, or any other kind of hazard. Classic signs may be rebuilt if damaged;

**E. Designated classic signs.**

A list of designated classic signs is maintained by the land use supervisor. (Ord. No. 10204, 3-11-2013, § 1; cited only in Ord. No. 10222, 5-13-2013, § 1.)

**50-27.12 Master mass transit shelter sign plan.**

---

- A. Following the effective date of this Section, a master mass transit shelter sign plan is required for any signage, other than route information, to be placed in or on any mass transit shelter located in a public right of way;
- B. The planning commission shall review the plan, conduct a public hearing pursuant to Section 50-37.1.I, with public notice as required by Section 50-37.1.H, and make a decision to approve, approve with modifications, or deny the application. The plan shall not allow for variations to the requirements of 50-27 with the exception of off-site commercial messaging;
- C. The master sign plan must provide a coordinated design for all signage to be located at or on all transit shelters of the applicant, including, at a minimum, criteria and specifications for sign locations, size of signage, single or double sided signage, lighting, and a maintenance plan for signage;
- D. The master mass transit shelter sign plan shall only apply to transit shelters that are approved by a concurrent use permit;
- E. Signage on a shelter must not exceed one-third of the vertical surface of the shelter, and must not impede the sight triangle as established in 50-25.2;
- F. After the date of this ordinance, mass transit shelters shall be permitted on public right-of-way only pursuant to a concurrent use permit issued pursuant to this chapter, and once the master sign plan has been approved signage erected must be maintained and operated only as provided for in the master mass transit shelter sign plan. (Ord. No. 10743, 4-26-2021§ 1.)



**50-28 STORMWATER DRAINAGE AND EROSION CONTROL.**

---

Stormwater drainage and erosion control regulations and standards apply to all lands in the city, and are contained in Section 50-18.1.E. (Ord. No. 10044, 8-16-2010, § 6.)

## 50-29 SUSTAINABILITY STANDARDS.

### 50-29.1 Applicability.

In order to promote sustainable development, all new residential development proposals containing three or more units, and all non-residential development with a gross floor area of 10,000 square feet or more, shall be required to comply with the provisions of this Section 50-29. (Ord. No. 10044, 8-16-2010, § 6.)

### 50-29.2 Points required.

Each new development shall be required to achieve at least a minimum number of points from the menu of options shown in Table 50-29-1:

- A. Residential development minimum requirements.
1. Residential development with 3-29 units: 3 points.
  2. Residential development with 30 or more units: 4 points;
- B. Non-residential development minimum requirements.
1. Non-residential development with 10,000 to 25,000 square feet: 3 points.
  2. Non-residential development with a total square footage of more than 25,000 square feet: 4 points;

<b>Table 50-29-1: Sustainability Point System</b>	
	<b>Points Earned</b>
<b>LOCATION</b>	
Development on previously used or developed land that is contaminated with waste or pollution (brownfield site with Environmental Site Assessment documented contamination that will be removed by property owner as part of the project)	<b>1.50</b>
Development on previously used or developed land that is not contaminated (site re-use)	<b>0.75</b>
Development on a previously undeveloped site that is located immediately adjacent to existing city roadway and utility infrastructure and that does not require additional public roadway and utility infrastructure to be constructed to service development.	<b>0.25</b>
<b>ENERGY EFFICIENCY</b>	
Meet ASHRAE standard 189.1 (Section 7.4.2) for building envelope design <sup>[1]</sup>	<b>1.50</b>
Meet ASHRAE standard 189.1 (Section 7.4.6) for lighting <sup>[1]</sup>	<b>0.75</b>
Meet ASHRAE standard 189.1 (Section 7.4.3) for HVAC equipment <sup>[1]</sup>	<b>0.75</b>
Meet Energy Star standards for low rise residential or exceed ASHRAE 90.1-2004 energy efficiency standards by 15%. <sup>[2]</sup>	<b>1.00</b>
<b>ALTERNATIVE ENERGY</b>	
Generate or acquire a minimum of 15% of the electricity needed by the development from alternative energy sources (solar, wind, etc)	<b>1.00</b>
Install solar panels on a minimum of 15% of homes dwelling units contained in one-family, two-family, or townhouse dwellings	<b>0.75</b>
Pre-wire a minimum of 10% of residential dwelling units for solar panels	<b>0.25</b>
Install solar panels on primary structure, or at least 50% of buildings in a multi-building complex	<b>0.75</b>
<b>PASSIVE SOLAR</b>	
A minimum of 20% of residential dwelling units or lots are oriented within 20% of east-west for maximum passive solar exposure	<b>1.00</b>
At least 20% of non-residential buildings have one longer axis oriented east-west for maximum solar exposure	<b>1.00</b>
<b>WATER</b>	
Install a "cool roof" on the primary structure, or at least 50% all of primary buildings in a multi-building complex. Cool roofs shall have a Solar Reflectance Index of 78 for flat roofs or 29 for roofs with a slope greater than 2:12.	<b>1.00</b>
Install a green vegetated roof on the primary structure, or at least 50% of all primary buildings in a multi-building complex. Green	<b>2.00</b>

or vegetated roofs shall include vegetation on at least 50% of the roof area (25% for renovated buildings) and shall use only plant materials permitted by the landscaping standards in Section 50-25.	
Meet ASHRAE standard 189.1 (Section 6.3.1) for site water use reduction <sup>[1]</sup>	<b>0.75</b>
Meet ASHRAE standard 189.1 (Section 6.3.2) for building water use reduction <sup>[1]</sup>	<b>0.50</b>
<b>STORMWATER, ADDITIONAL RETENTION</b>	
Post construction development will retain at least 0.5 inches of runoff on the site from impervious surfaces (retrain through infiltration, need proper native soils verified through geotechnical field testing approved by city engineer)	<b>0.50</b>
Post construction development will retain 1.1 inches of runoff on the site from impervious surfaces (retrain through infiltration, need proper native soils verified through geotechnical field testing approved by city engineer)	<b>0.75</b>
<b>VEGETATION</b>	
Retain at least 20% of existing pre-development native natural vegetation (minimum 5,000 square feet)	<b>0.50</b>
Turf grass is limited to 40% of the landscaped area. (minimum 5,000 square feet)	<b>0.25</b>
Maintain a minimum of 50 foot naturally vegetative buffer from delineated wetlands (minimum 25,000 feet of delineated wetlands on the property)	<b>0.50</b>
<b>URBAN AGRICULTURE</b>	
A fenced, centrally located community garden space is provided for residents and for urban gardening purposes at a ratio of 50 sq. ft. per dwelling unit as part of the overall landscape plan	<b>1.00</b>
A minimum of one on-site composting station is provided for every 25 units	<b>0.25</b>
<b>TRANSPORTATION</b>	
Source a minimum of 20% by cost of structure construction materials from recycled products or products manufactured, extracted, harvested, or recovered within 500 miles of the site (excluding gravel, fill, concrete, asphalt, and similar site construction material)	<b>1.50</b>
A minimum of 2% of required automobile parking spaces are signed and reserved for hybrid/electric/low energy vehicles in preferred locations near the primary building entrance	<b>0.25</b>
[1] <i>Standard for the Design of High-Performance Green Buildings</i> , American Society of Heating, Refrigerating, and Air-Condition Engineers, 2009.	
[2] <i>Energy Standard for Buildings Except Low-Rise Residential</i> , American Society of Heating, Refrigerating, and Air-Condition Engineers, 2004.	

(Ord No 10459, 7-11-2016, §2)

**C. LEED-certified building alternative.**

Buildings that have achieved LEED requirements necessary to receive certification from the U.S. green building council at the silver level or above shall not be required to meet the above requirements;

**D. Documentation required.**

Applicants shall provide documentation of techniques that will be used to satisfy the above requirement, as necessary, at the time of application submittal. Documentation for items that may not be visually verified as part of an inspection may be provided in the form of invoices, receipts, or delivery confirmation for the items in question. (Ord. No. 10044, 8-16-2010, § 6.)



## **50-30 DESIGN STANDARDS.**

The design standards of this Section 50-30 apply to all new development and all redevelopment or renovation of existing structures where the redevelopment or renovation expands the building gross square footage by more than 50 percent. (Ord. No. 10044, 8-16-2010, § 6; Ord. No. 10096, 7-18-2011, § 39.)

### **50-30.1 Multi-family residential design standards.**

Each principal structure or development in which a majority of the gross floor area is occupied by multi-family dwellings must comply with the standards set out in this Section, unless the provisions of Section 50-30.3, Mixed Use Development, apply:

#### **A. Accessibility.**

Multi-family dwelling developments containing more than one principal structure on a single lot or parcel must include an unobstructed walkway or pathway providing access between the principal structures for persons with disabilities. The walkway or pathway must be at least five feet wide, and, if curb ramps are necessary to provide such access, the curb ramps must comply with the slope and design requirements of the city;

#### **B. Façade length and articulation.**

Total length of any multi-family structure façade shall not exceed 300 feet and no façade wall shall extend more than 80 horizontal feet without projections or recesses. Each facade greater than 100 horizontal feet in length shall incorporate wall plane projections or recesses having a depth of at least three percent of the length of the facade and extending at least 20 percent of the length of the façade;

#### **C. Roof design.**

Rooflines longer than 100 horizontal feet shall include at least one vertical elevation change of at least two feet. All sloped roofs shall have overhanging eaves of at least one foot, and roofs with a pitch of less than 2:12 shall be screened by a parapet wall;

#### **D. Four-sided design.**

All sides of a structure open to view by the public, whether viewed from public or private property, shall display a similar level of quality and architectural interest;

#### **E. Parking structures and carports.**

To the maximum extent feasible, parking structures and carports shall not be located between the front or primary façade of a multi-family building and the street frontage adjacent to the front lot line, but shall instead be internalized within building groups so as not to be directly visible from the street frontage;

**F. Design features.**

At least three of the following design features shall be provided for visual relief along all facades of each primary multi-family building:

1. Roof dormers;
2. Gables;
3. Recessed entries;
4. Covered porches;
5. Cupolas;
6. Pillars, pilasters or posts;
7. Bay windows;
8. Eaves of at least 12 inches beyond the building wall or a parapet wall with an articulated design (decorative cornice, etc.);
9. Multiple windows with minimum four inches trim;
10. Recesses/shadow lines;
11. Building foundation areas that face streets or public areas shall be landscaped to a minimum width of five feet with a minimum of three shrubs per 20 lineal feet of foundation;

**G. Visibility of common areas.**

To promote public safety, primary multi-family dwelling structures and landscaping must be located and designed so that clear sight lines are provided to and between common open spaces, circulation paths and access points into the development, where applicable. (Ord. No. 10044, 8-16-2010, § 6; Ord. No. 10096, 7-18-2011, § 40, Ord. No. 10813, 9-12-22 §4)

**50-30.2 Commercial and institutional design standards.**

---

**A. Applicability.**

1. The standards of this Section 50-30.2 shall apply to each principal building or development in which a majority of the gross floor area is occupied by uses categorized in Table 50-19.8 as commercial and institutional uses, except for:
  - (a) Any building or development located in one of the form districts;
  - (b) Any building or development located on a lot smaller than 10,000 square feet;
  - (c) Any building or development containing less than 10,000 square feet of gross floor area;
2. If a building or development containing less than 10,000 square feet of gross floor area is later expanded so that it contains 10,000 square feet of gross floor area or more, it shall be subject to these requirements;

**B. Facades and articulation.**

Each commercial or institutional principal structure, other than large retail structures addressed in Section 50-30.2.D below, shall meet the transparency requirement described in subsection 1 below, and shall also comply with two of the remaining options listed in subsections 2 through 5 below, with the choice of those standards to be at the option of the owner:

1. Transparency requirement.  
A minimum of ten percent of each facade area that faces a street shall be composed of transparent materials. At least 1/2 of this amount shall be provided so that the lowest edge of the transparent materials is no higher than four feet above the street level;
2. Wall plane articulation option.  
Each facade greater than 100 feet in length abutting a street shall incorporate architectural features such as wall plane projections, recesses, or other building material treatments and textures that visually interrupt the wall plane. No uninterrupted length of any facade shall exceed 100 horizontal feet;
3. Vertical articulation option.  
Each principal building taller than 30 feet in height must be designed so that the massing or façade articulation of the building presents a clear base, middle and top when viewed from the abutting street;

4. Roof articulation option.  
Where sloping roofs are used, at least one projecting gable, hip feature, or other break in the horizontal line of the roof ridgeline shall be incorporated for each 60 lineal feet of roof. Where flat roofs are used, the design or height of the parapet shall include at least one change in setback or height of at least three feet along each 60 lineal feet of façade;
5. Foundation landscaping option.  
Building foundation areas that face streets or public areas shall be landscaped to a minimum width of five feet with a minimum of three shrubs per 20 lineal feet of foundation;

#### C. Entryway design and location.

Each principal building shall have clearly defined, highly visible main entrances for occupants and customers with features designed to emphasize the importance of the entrance, which must include at least two of the following features, with the choice of the features to be at the option of the owner:

1. A canopy or portico;
2. A roof overhang;
3. A horizontal recess or projection;
4. An arcade or arch;
5. A peaked roof form;
6. An outside patio;
7. A display window;
8. Architectural tilework or moldings integrated into the building design;
9. Integrated planters or wing walls that incorporate landscaped areas or seating areas;
10. Another architectural feature not found on the remainder of that building façade;

#### D. Additional standards for large commercial retail buildings.

In addition to meeting the standards in subsection A above, single-story retail buildings containing 65,000 square feet or more of gross floor area, in which one user or tenant occupies more than 75 percent of the gross floor area, shall meet the following additional standards:

1. Facade articulation.

Each building facade longer than 100 feet shall incorporate wall plane projections or recesses at least two feet deep, and extending at least 20 percent of the length of the façade. At least one of those wall plane projections or recesses shall repeat horizontally at an interval of no more than 30 feet;

2. Facade design.

Each building façade must have a repeating pattern that includes at least two instances of at least one of the following:

- (a) Color change;
- (b) Texture change;
- (c) Material module change;
- (d) Expression of an architectural or structural bay through a change in plane no less than 12 inches wide, such as an offset, reveal or projecting rib;

3. Pedestrian oriented design features.

Ground-floor façades that face public streets or accessory parking areas shall have arcades, display windows, entry areas, awnings or other such features along no less than 60 percent of their horizontal length;

4. Pedestrian connections.

All principal entrances of principal buildings shall have direct access (i.e., access without having to cross a public street) to a sidewalk, walkway, path or pathway that leads to a public street. Each such sidewalk, walkway, path or pathway must be a minimum of five feet wide. If a sidewalk does not currently exist, and there is a sidewalk system in place, sidewalks on the property shall connect to the existing sidewalk system;

5. Bicycle access.

Bicycle access shall be provided between public bicycle lanes, paths, or routes on adjacent streets and on-site bicycle parking areas. Sites should be designed to avoid or minimize all conflicting bicycle/motor vehicle and bicycle/pedestrian movements;

**E. Special provisions for MU-B district.**

Not less than 30 percent of the exterior walls of all buildings shall be covered with finish grade brick, stone, concrete or masonry. No metal roofing materials shall be visible;

**F. Alternate commercial and institutional design.**

In lieu of compliance with the specific requirements of this Section 50-30.2, an owner may propose to the land use supervisor an alternative approach consistent with the intent of this Section. The land use supervisor may approve a proposal under this Section only if the proposed alternative achieves required façade design and articulation, entryway design and location, pedestrian oriented design features, pedestrian connections and bicycle access to the same degree or better than the provisions of this Section. (Ord. No. 10044, 8-16-2010, § 6; Ord. No. 10096, 7-18-2011, § 41.)

**50-30.3 Mixed use design standards.**

---

In a mixed use development, each residential principal building must comply with residential design standards, each commercial or institutional building must comply with commercial design standards, and each industrial building must comply with industrial design standards, unless the applicant chooses to request one of the alternative design requirements below.

**A. Residential/commercial.**

If a mixed use development contains a mix of (a) principal multi-family uses and (b) principal commercial, public, institutional, or civic uses, the applicant shall comply with the multi-family design standards in Section 50-30.1 and the ground floor transparency standards in Section 50-30.2.B.1.

**B. Commercial/industrial.**

If a mixed use development contains a mix of (a) principal commercial or institutional uses and (b) principal industrial uses the applicant may choose to comply with either the commercial or industrial design standards. (Ord. No. 10044, 8-16-2010, § 6.)



### 50-30.4 Industrial design standards.

Each principal building, except a building greater than 100,000 square feet in gross floor area in the MU-B, I-G and I-W districts, or development in which a majority of the gross floor area is occupied by uses categorized industrial uses in Table 50-19.8 must comply with the following standards, unless the provisions applicable to mixed use development apply.

#### A. Facade articulation.

Each industrial principal building must meet at least one of the following four standards, with the choice of the standard to be at the option of the owner:

1. Wall plane horizontal articulation option.

Each facade greater than 100 feet in length abutting a street, measured horizontally, must incorporate architectural features such as wall plane projections, recesses or other building material treatments and textures that visually interrupt the wall plane. No uninterrupted length of any facade may exceed 100 horizontal feet;

2. Vertical articulation option (for buildings taller than 30 feet).

Each principal building greater than 30 feet in height must have a change in cladding material or surface plane. No single cladding material or surface plane may extend for an uninterrupted vertical distance of more than 30 feet;

3. Parapet variation option.

All facades visible from a public street must include a parapet that varies in height by at least two feet for each 60 lineal foot of facade length;

4. Foundation landscaping option.

Building foundation areas that face streets or public areas shall be landscaped to a minimum width of five feet with a minimum of three shrubs per 20 lineal feet of foundation;

#### B. Entryway design.

Each principal building must have clearly defined, highly visible main entrances for occupants and patrons with features designed to emphasize the importance of the entrance, including at least one of the following elements, with the choice of the element to be at the option of the owner:

1. Canopy or portico;
2. Roof overhang;
3. Horizontal recess or projection;
4. Arcade or arch;
5. Peaked roof form;
6. Outside patio;
7. Display window;
8. Architectural tilework or moldings integrated into the building design;
9. Integrated planters or wing walls that incorporate landscaped areas or seating areas;
10. Similar architectural feature not found on the remainder of that building facade. (Ord. No. 10044, 8-16-2010, § 6.)

**50-30.5 Parking structure design standards.**

---

Each primary use or accessory parking garage shall comply with the following requirements:

- A. Each façade of the parking structure that faces a public street shall contain, or have the appearance of containing, horizontal (rather than sloped) floor planes and shall not reveal interior ramps;
- B. All sides of the parking structure not occupied by retail, office or residential uses must be articulated through the applicant's choice of at least three of the following:
1. Windows or window shaped openings;
  2. Decorative wall insets or projections;
  3. Awnings;
  4. Changes in color or texture of materials;
  5. Public art approved by the Duluth public arts commission pursuant to its established review and approval criteria;
  6. Integrated landscape planters;
  7. Pedestrian-scaled lighting;
  8. Benches, plazas, or other pedestrian areas;
  9. Other features as approved by the land use supervisor as providing an equivalent degree of architectural articulation, visual interest or pedestrian amenity;
- C. Openings in the podium or tuck under parking areas shall be screened with architectural screens. (Ord. No. 10044, 8-16-2010, § 6; Ord. No. 10096, 7-18-2011, § 42; Ord. No. 10153, 5-14-2012, § 12.)

## **50-31 EXTERIOR LIGHTING.**

---

### **50-31.1 Applicability.**

---

#### **A. General.**

Unless excepted in subsection B below, all exterior lighting on lots and parcels in any zone district that contain a primary structure with a multi-family, mixed use, commercial, institutional, industrial or parking principal use, when any of the following conditions occur shall comply with the standards of this Section 50-31:

1. A new primary structure is constructed;
2. The floor area in an existing primary structure(s), taken collectively, is increased by more than 25 percent;
3. An existing primary structure is relocated on the lot or parcel;
4. The primary structure is renovated or redeveloped (including but not limited to reconstruction after fire, flood or other damage), and the value of that renovation or redevelopment, as indicated by building permits, is more than 25 percent of the market value of the land and buildings, as indicated by tax assessor's records;

#### **B. Exceptions.**

The following types of lighting are not subject to the requirements of this Section 50-31:

1. Public street and right-of-way lighting;
2. Temporary decorative seasonal lighting;
3. Temporary lighting for emergency or nighttime work and construction;
4. Temporary lighting for theatrical, television and performance areas, or for special public events;
5. Lighting for a special district, street or building that, according to an adopted city plan or ordinance, is determined to require special lighting aesthetics as part of its physical character;
6. Lighting required and regulated by the FAA;
7. Lighting for outdoor recreational uses such as ball diamonds, playing fields, tennis courts and similar uses, provided that (a) light poles are not more than 80 feet tall, (b) maximum illumination at the property line is not brighter than two footcandles, and exterior lighting is extinguished no later than 11:00 p.m. (Ord. No. 10044, 8-16-2010, § 6; Ord. No. 10096, 7-18-2011, § 43.)

### **50-31.2 General review standard.**

---

If installed, all exterior lighting shall meet the functional security needs of the proposed land use without adversely affecting adjacent properties or the community. For purposes of this Section 50-31, properties that comply with the design standards of Section 50-31.3 below shall be deemed to not adversely affect adjacent properties or the community. (Ord. No. 10044, 8-16-2010, § 6.)

**50-31.3 Design and illumination standards.**

All exterior lighting regulated by this Section shall not be altered or replaced except where the alteration or replacement would comply with the provisions of this Section. All exterior lighting shall meet the following design standards:

- A. Any light source or lamp that emits more than 900 lumens (13 watt compact fluorescent or 60 watt incandescent) shall be concealed or shielded with an Illuminations Engineering Society of North America (IESNA) full cut-off style fixture with an angle not exceeding 90 degrees, with 90 percent of the light below 80 degrees. Exterior lighting shall be designed, constructed, and maintained in a manner that minimizes off-site glare, light trespass on adjacent property, and traffic hazards for pedestrian and motorists;

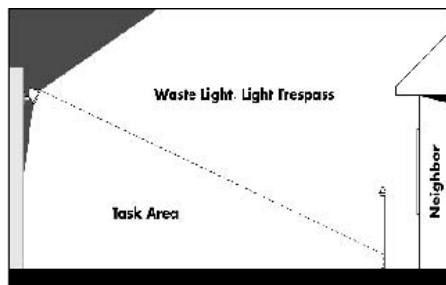

**Figure 50-39.1-A: Does not comply -- Light trespass**

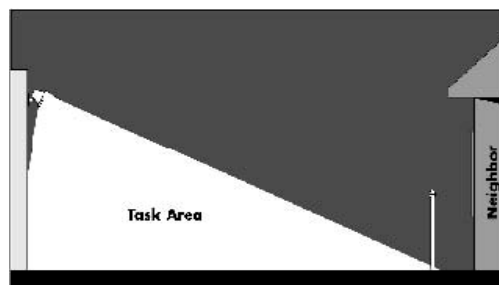

**Figure 50-39.1-B: Complies -- No light trespass**

- B. All lighting shall have the intensities and uniformity ratio consistent with the IESNA lighting handbook, and shall be designed and located so that the illumination measured in footcandles at the finished grade shall comply with the standards in Table 50-31-1, *Minimum and Maximum Illumination Values*. All exterior lighting shall meet the requirements of the Minnesota State Energy Code, except for temporary decorative seasonal lighting;

Table 50-31-1: Minimum and Maximum Illumination Values (in Footcandles)				
Use	Maximum Illumination on Property	Maximum Illumination at Property Line (Excluding Rights-of-Way)	Maximum Illumination at Right-of-Way	Maximum/Minimum Ratio in an Illuminated Area
Residential Uses and Agricultural and Animal Related Uses	5	.5	1.0	10:1
All Other Uses	10	1.0	2.0	15:1

- C. The maximum height of any lighting pole serving a residential use is 20 feet. The maximum height serving any other type of use is 25 feet, except that (1) in parking lots larger than five acres, the maximum height of any pole located at least 100 feet from any residential use is 35 feet, and (2) in the I-G and I-W zone districts, the maximum pole height is 50 feet; The calculation for the height of lighting poles excludes the pole's base (up to 30 inches);
- D. Sign illumination shall conform to the provisions of Section 50-27.
- E. Lighting of free standing canopies for automobile service stations, convenience stores, and other similar uses shall have a maximum light level of 15 footcandles. Lighting shall be fully recessed into the canopy and shall not protrude downward beyond the ceiling of the canopy. Maximum lighting level uniformity (maximum to minimum) on the site shall be 15:1;

- F. The use or operation of searchlights for advertising purposes is prohibited. The use of laser source light or any similar high intensity light for outdoor advertising or entertainment, when projected above the horizon, is prohibited;
  - G. All outdoor light not necessary for security purposes shall be reduced to 30 percent of design levels or less, activated by motion sensor detectors, or turned off during non-operating hours;
  - H. Light fixtures used to illuminate statues, monuments, or any other objects mounted on a pole, pedestal or platform shall use a narrow cone beam of light that will only illuminate the object;
  - I. For upward-directed architectural, landscape and decorative lighting, and flood lights, direct light emissions shall be contained by the buildings and not be visible above the building roof line, and shall not be utilized to light any portion of a building façade between 10:00 p.m. and 6:00 a.m.;
  - J. No flickering or flashing lights shall be permitted, except for temporary decorative seasonal lighting.
  - K. LED lighting may not exceed a correlated color temperature (CCT) of 3000 Kelvin (K) nor have a minimum color rendering index (CRI) of less than 80. This provision does not apply to lighting serving a public or quasi-public institution for public safety or security purposes as determined by the Land Use Supervisor, or street lighting provided by the city, county, or the state of Minnesota.
- (Ord. No. 10044, 8-16-2010, § 6; Ord. No. 10153, 5-14-2012, § 13, Ord. No. 10813, 9-12-22, §3)

**50-32 HOUSING AND PROPERTY MAINTENANCE CODE.**

---

The city has adopted by reference the year 2012 edition of the International Property Maintenance Code, as the Housing and Property Maintenance Code of the city, as amended by Chapter 29A of the code. (Ord. No. 10044, 8-16-2010, § 6. Ord. No. 10459, 7-11-2016, §3)

## 50-33 PLATS.

---

### 50-33.1 General.

---

All subdivision plats and replats, and all registered land surveys, shall create lots, streets and walkways and open spaces consistent with the requirements of the zone district within which the land is located. Without limiting the generality of the previous sentence, all plats and land surveys approved after November 19, 2010, shall be consistent with the lot dimension requirements contained in sections 50-13 through 18 of this Chapter, as well as the requirements of Section 50-21, *Dimensional requirements*, 50-22, *Building form standards*, 50-23, *Connectivity and circulation*, 50-24, *Parking and loading*, and 50-18.1.E, *Stormwater and erosion control*. In addition, all subdivision plats and replats, and all registered land surveys approved after November 19, 2010, shall comply with the standards of this Section 50-33. (Ord. No. 10044, 8-16-2010, § 6.)

### 50-33.2 Site design.

---

- A. The site design process shall begin with an analysis of site constraints and natural resources, and shall avoid both to the degree practicable;
- B. In addition, the site design process shall include a pre-submittal evaluation of storm drainage to ensure that the proposed design will comply with the storm drainage and erosion control standards in Section 50-18.1.E. This study shall be submitted prior to submission of a preliminary plat of the property;
- C. The site design process shall include an evaluation of minimal impact development and low impact development methods;
- D. At a minimum, the lands included in the plat or survey shall be designed so that all developable parcels can be developed in compliance with the requirements of:
  1. Section 50-18.1, *Natural resources overlay district*, which identifies areas subject to flood plain, shorelands and wetland constraints, and stormwater and erosion control;
  2. Section 50-18.4, *Skyline Parkway overlay district*, which identifies constraints on the location of structures and fences on lands located within 200 feet downhill of Skyline Parkway;
- E. Shore and bluff impact zones shall be included in common open space. Wetlands, floodplains, wildlife areas, steep slopes, rock outcrops, tree stands and areas in their natural state that are unsuitable for development shall be included in common open space if possible;
- F. Whenever a portion of a tract is proposed for platting and it is intended to enlarge such platted portion in the future, a tentative plan for the entire tract shall be submitted;
- G. To ensure a harmonious development in areas not subject to any zoning ordinance (areas now outside the corporate limits of Duluth), the subdivider may be required to place upon such plats restrictions comparable to those of this Chapter for similar areas. (Ord. No. 10044, 8-16-2010, § 6; Ord. No. 10096, 7-18-2011, § 44.)

### 50-33.3 Block size.

---

- A. In the MU-B, I-G and I-W zone districts, block lengths and widths shall be platted to accommodate the anticipated occupancy of the platted lots;
- B. In other zone districts, blocks shall be not less than 300 feet nor more than 600 feet in length;
- C. Through lots or double-frontage lots shall be avoided as far as practicable, but may be permitted when necessary to allow efficient use of the land in light of site topography. (Ord. No. 10044, 8-16-2010, § 6.)

### 50-33.4 General lot design and layout.

---

- A. All lots shall have frontage on a public street unless that is impracticable due to topography and the land use supervisor approves an alternative layout based on considerations of public safety and land use efficiency;
- B. Where practicable, side lot lines shall be at approximately right angles to the street on which the lot fronts;
- C. Where practicable, adjacent lots shall not be platted so that their long axes are at right angles to each other;

- D. No strips of land shall be platted for private ownership that control access to public streets or that are untaxable for special improvements;
- E. Where practicable, lots shall be oriented so that the long axis of the lot is within 15 degrees of east-west in order to increase solar orientation;
- F. Flag lots are prohibited in R-1, R-2 and MU-N zone districts. (Ord. No. 10044, 8-16-2010, § 6; Ord. No. 10096, 7-18-2011, § 45; Ord. No. 10286, 3-10-2014, § 16.)

**50-33.5 Specific layout standards for R-C, RR-1 and RR-2 districts.**

---

- A. When (i) a tract or parcel of land in the R-C or RR-1 districts, or (ii) a parcel of land in the RR-2 districts with sewer service, is proposed for platting to create five or more residential building lots, those lots shall be clustered as described in this Section in order to retain the open character of the land and reduce the amount of the tract occupied by building sites;
- B. When these clustering requirements apply:
  - 1. The applicant may create only as many residential building lots as would be permitted under the minimum lot size provisions of sections 50-14.2, 50-14.3 or 50-14.4;
  - 2. If the parcel does not have sewer service, the minimum lot size for residential use shall be two acres and the maximum lot size shall be two- and-one-half acres. All new residential lots shall be clustered in close proximity to each other on a portion of the property that complies with the siting requirements of Section 50-21.2 so that the shortest line around the outer perimeter of all new residential lots encloses an area of land that:
    - a. In the R-C district, totals less than 20 percent of the total parcel being subdivided;
    - b. In the RR-1 district, totals less than 50 percent of the total parcel being subdivided;
  - 3. If the parcel has sewer service, the minimum lot size for residential use shall be one-half acre and the maximum lot size shall be one acre. All new residential lots shall be clustered in close proximity to each other on a portion of the property that complies with the siting requirements of Section 50-21.2 so that the shortest line around the outer perimeter of all new residential lots encloses an area of land that:
    - a. In the R-C district, totals less than 15 percent of the total parcel being subdivided;
    - b. In the RR-1 district, totals less than 25 percent of the total parcel being subdivided;
    - c. In the RR-2 district, totals less than 50 percent of the total parcel being subdivided;
  - 4. To the maximum extent practicable, existing historic rural features shall be preserved as part of the cluster development. These features include but are not limited to rock walls, fences, functional and structurally safe farm buildings, monuments and landscape features;
  - 5. To the maximum extent practicable, in the R-C district, the clustered residential lots shall be located so as to reduce visibility of residential development on the parcel when viewed from public streets adjacent to the parcel;
  - 6. To the maximum extent practicable, the portion of the parcel not occupied by clustered residential lots shall be contiguous, shall not be fragmented by public or private road easements unless no other reasonable alternative exists, shall include any natural features listed in Section 50-33.2, and shall connect with open space on neighboring parcels in order to connect habitats and reduce fragmentation;
  - 7. The portion of the parcel not occupied by clustered residential lots shall remain available for the use and benefit of the owners of the clustered residential lots, and need not be made available for the use or benefit of the public;
  - 8. The portion of the parcel not occupied by clustered residential lots shall be shown on the preliminary and final plat, shall be owned and managed by a homeowners association and shall be encumbered through an easement, restrictive covenant, or other instrument suitable to the city to ensure that that it will provide continuing visual or use benefits to the owners of clustered residential lots and will not be developed until such time as the city may rezone all or a portion of the development for more intensive development;



9. The city may require the creation of a homeowner's association or other organization for ownership and maintenance of those portions of the property not included in clustered residential lots. (Ord. No. 10044, 8-16-2010, § 6.)

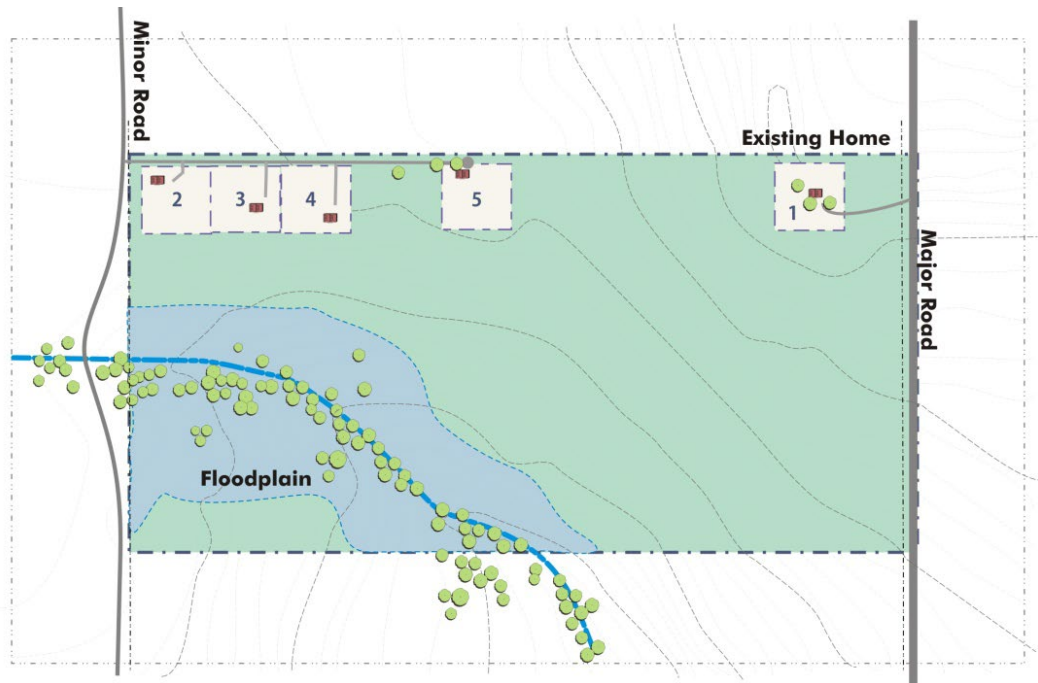

### **50-33.6 Streets.**

---

#### **A. Alignment.**

1. New streets shall align with the existing street network on the same general alignment if practicable, unless the city engineer advises that an offset or alternate alignment is needed for public safety or topography;
2. Streets shall intersect at approximately right angles wherever practicable, and intersection angles less than 30 degrees shall be avoided;
3. On major and secondary streets the centerline radius of curvature shall be 350 feet. On minor and local streets the centerline radius of curvature shall be 100 feet;
4. Cul-de-sacs are discouraged in new and replatted developments except where through streets are not practicable due to site or topography constraints;

#### **B. Grade.**

1. Streets shall conform to existing contours as far as practicable so as to avoid grades in excess of five percent on major and secondary streets and ten percent on minor and local streets. Changes in grade shall be made by vertical curves of such length to meet the design speed of the road;
2. Where practicable, grades within 30 feet of street intersections, especially intersections on major streets, should not exceed three percent;
3. Where practicable, horizontal and vertical curves shall not occur together;

#### **C. Width.**

1. Major streets shall be platted at those widths shown in the major street plan and collector and local streets shall be platted not less than 66 feet, or 50 feet if there are no utilities, in right-of-way width, except as noted in subsection 2 below;
2. Where the plat includes parkways, streets along railway rights-of-way, immediate or future grade separations, bridges or viaducts, the city engineer shall specify the street width at the time of platting based on considerations of public safety and land use efficiency;
3. Dead-end streets shall be provided with ample turning spaces at or near the closed ends.

#### **D. Names.**

Proposed streets that are direct extensions or continuations of existing streets shall be given the same names as those existing streets. Other streets shall not be given names that duplicate existing street names or that may be confused with existing street names. The City Engineer shall review and approve all proposed street names in all subdivisions that are submitted for Planning Commission review and approval;

#### **E. Private and public streets.**

Except as specifically provided for in this chapter, such as 50-14.7, 50-15.7, or 50-20.1.G, every new street shall be a public street designed to city of duluth engineering guidelines and construction standards. (Ord. No. 10044, 8-16-2010, § 6; Ord. No. 10733, 1-11-2021, § 5; Ord. No. 10801, 4-11-2022, § 3).

### **50-33.7 Alleys and easements.**

---

- A. Alleys are encouraged in form districts and where the existing lot and block pattern in the surrounding area contains alleys. Where allowed they shall be not less than 20 feet in width in residential areas and 24 feet in width in commercial and mixed use areas;
- B. Where no alleys are located, the city engineer may require easements, not less than ten feet on each side of any lot line, for sewer, water, gas, telecommunications and other public or semi-public utilities;
- C. Regardless of whether alleys are provided, the city engineer may require that utility easements be provided across platted lots if necessary for the proper provision of continuous routes for those utilities. (Ord. No. 10044, 8-16-2010, § 6.)

### **50-33.8 Land for public purposes.**

---

- A. The subdivider may be required to set aside lands to accommodate open spaces and sites for police stations, fire stations, schools or public utility facilities;
- B. The amount of land required to be set aside or dedicated to the city or the school district shall not exceed the proportionate share of the need for those facilities generated by the new development indicated on the proposed plat. The proportionate share shall be established either (1) through one or more formulas established by the city and generally applicable to development applications creating the need for the facility, or (2) an individualized review of the additional demands for city services or facilities represented by the proposed plat, in relation to the proposed capacity of the facility to be constructed on the lands set aside;
- C. Lands to be set aside for parks, trails or open space shall generally be located adjacent to, or connect with, or allow access from, any similar open lands located on adjacent lands, unless the city requests an alternate location for reasons of public health, safety or convenience;
- D. The size and location of lands to be set aside for police stations, fire stations, schools or utility facilities shall be negotiated with the city or the agency providing those services. (Ord. No. 10044, 8-16-2010, § 6.)

### **50-33.9 Improvements required.**

---

Each subdivider shall be required to design and install the following improvements within five years following the approval of the plat, replat or registered land survey by the city. The city may enforce these requirements through a development agreement or the requirement of financial security for the required improvements as described in Article V, *Review and approval procedures*.

- A. All streets located within the boundaries of the tract being subdivided or replatted shall be graded to established grade and surfaced with an approved material, in accordance with standards of the city engineering department;
- B. Storm sewers shall be constructed of sufficient capacity to drain the area in accordance with standards of the city engineering department;
- C. Culverts or bridges shall be built at points on watercourses crossed by streets;
- D. Sidewalks shall be constructed in accordance with Section 50-23;
- E. All improvements to streets or public utilities shall be made in accordance with city construction design standards and specifications, and shall be subject to the inspection by and approval of the city engineer. (Ord. No. 10044, 8-16-2010, § 6.)

## **50-34 MAINTENANCE AND OPERATING STANDARDS.**

---

### **50-34.1 General maintenance requirement.**

---

When the standards and procedures of this Chapter require that any building or site feature be constructed or installed, or when conditions attached to a special use approval, variance or zoning permit approval require that building or site features be constructed or installed, the property owner shall be responsible for maintaining those building or site features in good repair, and for replacing them if they are damaged or destroyed or, in the case of living materials, if they die after installation. In addition, property owners shall be responsible for the additional maintenance, replacement and operating standards set forth in this Section 50-34.

#### **A. Maintenance of signs.**

Any private sign, including any sign for which a permit is not required, that has become damaged, dilapidated or dangerous shall be immediately, or within the time frame mandated by the building official, repaired or removed. If the paint on any sign has checked, peeled or flaked to the extent that the sign cannot be read in whole or in part, the sign shall be repainted or removed. Signs that contain messages that have become obsolete because of the termination of the use or business or product advertised, or for some other reason, shall have such message removed within 60 days of its becoming obsolete;

#### **B. Landscape maintenance.**

Landscaped areas and plant materials required by this Chapter shall be kept free from refuse and debris. Plant materials shall be maintained in a healthy growing condition and be neat and orderly in appearance. If any plant material required by this Chapter dies or becomes diseased, it shall be replaced by the property owner on or before October 1 of the year the dead or diseased planting is discovered or within the time frame mandated by the building official;

#### **C. Temporary erosion and sediment control maintenance.**

All temporary erosion and sediment control measures required by Section 50-18.1.E shall be maintained as described in Section 50-18.1.E.4.

#### **D. Stormwater management system maintenance.**

All stormwater management systems required by Section 50-18.1.E shall be maintained as described in Section 50-18.1.E.8. (Ord. No. 10044, 8-16-2010, § 6.)

### **50-34.2 Operating standards.**

---

All structures, uses and activities in all zone districts shall be used or occupied so as to avoid creating any dangerous, injurious, noxious or otherwise objectionable condition that would create adverse impacts on the residents, employees or visitors on the property itself or on neighboring properties. This responsibility shall include but not be limited to the following:

#### **A. Glare.**

Glare, whether direct or reflected, such as from floodlights or high temperature processes, and as differentiated from general illumination, shall not be visible at any property line;

#### **B. Noise.**

All activities shall comply with state statutes and regulations;

#### **C. Odors.**

All activities shall comply with state statutes and regulations;

#### **D. Smoke.**

All activities shall comply with state statutes and regulations;

#### **E. Vibration.**

Operations shall cause no inherent and recurring generated vibration perceptible without instruments at any point along the property line. Temporary construction is excluded from this restriction;

#### **F. Electromagnetic radiation.**

It shall be unlawful to operate, or cause to be operated, any planned or intentional source of electromagnetic radiation for such purposes as communication, experimentation, entertainment, broadcasting, heating, navigation, therapy, vehicle velocity measurement, weather survey, aircraft detection, topographical survey, personal pleasure or any other use directly or indirectly associated with these purposes that does not comply with the current regulations of the FCC regarding such sources of electromagnetic radiation. However, in case of governmental communications facilities, governmental agencies, and government owned plants, the regulations of the interdepartmental radio advisory committee shall take precedence over the regulations of the FCC regarding those sources of electromagnetic radiation;

#### **G. Hazardous materials.**

The storage and handling of flammable liquids, liquefied petroleum, gases and explosives shall comply with all applicable regulations of the state. All applicable federal, state and local laws, rules and regulations shall apply to the treatment, storage, transportation and disposal of any hazardous materials, hazardous wastes or solid waste;

#### **H. Materials and waste handling.**

No person shall cause or permit any materials to be handled, transported or stored in a manner that allows particulate matter to become airborne or liquid matter to drain onto or into the ground. All materials or wastes that might cause fumes or dust or that constitute a fire hazard or that may be edible by or otherwise be attractive to rodents or insects shall be stored outdoors only in closed, impermeable trash containers that are screened in accordance with the requirements of this Code. Toxic and hazardous materials and chemicals shall be stored, secured and maintained so that there is no contamination of ground, air or water sources at or adjacent to the site. Provisions shall be provided so that all lubrication and fuel substances shall be prevented from leaking or draining onto the property. All treatment, storage, disposal or transportation of hazardous waste shall be in conformance with all federal and state statutes, codes and regulations. All sewage and industrial wastes shall be treated and disposed of in such a manner as to comply with the water quality standards applicable to the classification assigned to the receiving water by the city, the state and the U.S. environmental protection agency;

**H. Nuclear radiation.**

Research operations shall cause no radiation at any property line that violates any regulation of the U.S. nuclear regulatory commission;

**I. Nuisance prohibited.**

All structures and land uses within the city shall be constructed, used, operated and maintained in such a manner so as to be free of nuisances, as defined in state law. (Ord. No. 10044, 8-16-2010, § 6.)